

bulletin

SPACE FOR EUROPE



European Space Agency

The European Space Agency was formed out of, and took over the rights and obligations of, the two earlier European space organisations – the European Space Research Organisation (ESRO) and the European Launcher Development Organisation (ELDO). The Member States are Austria, Belgium, Denmark, Finland, France, Germany, Greece, Ireland, Italy, Luxembourg, the Netherlands, Norway, Portugal, Spain, Sweden, Switzerland and the United Kingdom. Canada is a Cooperating State.

In the words of its Convention: the purpose of the Agency shall be to provide for and to promote for exclusively peaceful purposes, cooperation among European States in space research and technology and their space applications, with a view to their being used for scientific purposes and for operational space applications systems:

- (a) by elaborating and implementing a long-term European space policy, by recommending space objectives to the Member States, and by concerting the policies of the Member States with respect to other national and international organisations and institutions;
- (b) by elaborating and implementing activities and programmes in the space field;
- (c) by coordinating the European space programme and national programmes, and by integrating the latter progressively and as completely as possible into the European space programme, in particular as regards the development of applications satellites;
- (d) by elaborating and implementing the industrial policy appropriate to its programme and by recommending a coherent industrial policy to the Member States.

The Agency is directed by a Council composed of representatives of the Member States. The Director General is the chief executive of the Agency and its legal representative.

The ESA HEADQUARTERS are in Paris.

The major establishments of ESA are:

ESTEC, Noordwijk, Netherlands.

ESOC, Darmstadt, Germany.

ESRIN, Frascati, Italy.

ESAC, Madrid, Spain.

Chairman of the Council: P. Tegner

Director General: J.-J. Dordain

Agence spatiale européenne

L'Agence spatiale européenne est issue des deux Organisations spatiales européennes qui l'ont précédée – l'Organisation européenne de recherches spatiales (CERS) et l'Organisation européenne pour la mise au point et la construction de lanceurs d'engins spatiaux (CECLES) – dont elle a repris les droits et obligations. Les Etats membres en sont: l'Allemagne, l'Autriche, la Belgique, le Danemark, l'Espagne, la Finlande, la France, la Grèce, l'Irlande, l'Italie, le Luxembourg, la Norvège, les Pays-Bas, le Portugal, le Royaume-Uni, la Suède et la Suisse. Le Canada bénéficie d'un statut d'Etat coopérant.

Selon les termes de la Convention: l'Agence a pour mission d'assurer et de développer, à des fins exclusivement pacifiques, la coopération entre Etats européens dans les domaines de la recherche et de la technologie spatiales et de leurs applications spatiales, en vue de leur utilisation à des fins scientifiques et pour des systèmes spatiaux opérationnels d'applications:

- (a) en élaborant et en mettant en oeuvre une politique spatiale européenne à long terme, en recommandant aux Etats membres des objectifs en matière spatiale et en concertant les politiques des Etats membres à l'égard d'autres organisations et institutions nationales et internationales;
- (b) en élaborant et en mettant en oeuvre des activités et des programmes dans le domaine spatial;
- (c) en coordonnant le programme spatial européen et les programmes nationaux, et en intégrant ces derniers progressivement et aussi complètement que possible dans le programme spatial européen, notamment en ce qui concerne le développement de satellites d'applications;
- (d) en élaborant et en mettant en oeuvre la politique industrielle appropriée à son programme et en recommandant aux Etats membres une politique industrielle cohérente.

L'Agence est dirigée par un Conseil, composé de représentants des Etats membres. Le Directeur général est le fonctionnaire exécutif supérieur de l'Agence et la représente dans tous ses actes.

Le SIEGE de l'Agence est à Paris.

Les principaux Etablissements de l'Agence sont:

ESTEC, Noordwijk, Pays-Bas.

ESOC, Darmstadt, Allemagne.

ESRIN, Frascati, Italie.

ESAC, Madrid, Espagne.

Président du Conseil: P. Tegner

Directeur général: J.-J. Dordain

Editorial/Circulation Office

ESA Communications
ESTEC, PO Box 299,
2200 AG Noordwijk
The Netherlands
Tel: +31 71 565-3408

Editors

Carl Walker
Karen Fletcher
Dorothea Günther-Danesy

Design & Layout

Isabel Kenny
Eva Ekstrand

Advertising

Lorraine Conroy

The ESA Bulletin is published by the European Space Agency. Individual articles may be reprinted provided the credit line reads 'Reprinted from ESA Bulletin', plus date of issue. Signed articles reprinted must bear the author's name. Advertisements are accepted in good faith; the Agency accepts no responsibility for their content or claims.

Copyright © 2008 European Space Agency
Printed in the Netherlands ISSN 0376-4265



An artist's impression of the GOCE (Gravity field and steady-state Ocean Explorer) satellite. GOCE is the first core Earth Explorer satellite to be developed as part of ESA's Living Planet Programme and is scheduled for launch from the Russian Plesetsk Cosmodrome in 2008. (ESA/AOES Medialab)



2

One of ESA's Most Challenging Missions Yet

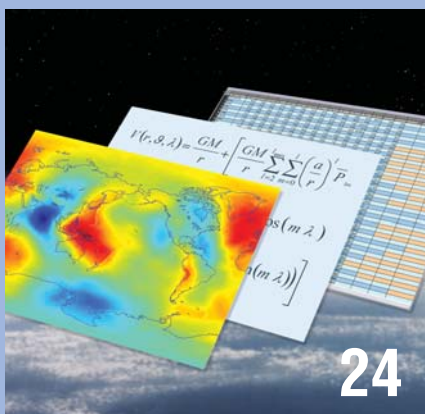

24

Measurements of the Gravity Field and Beyond



32

A Bigger and Better Time Machine



42

Europe's Eyes on the Skies
Space Surveillance



50

Welcome to Space
Retaining European Space Competencies

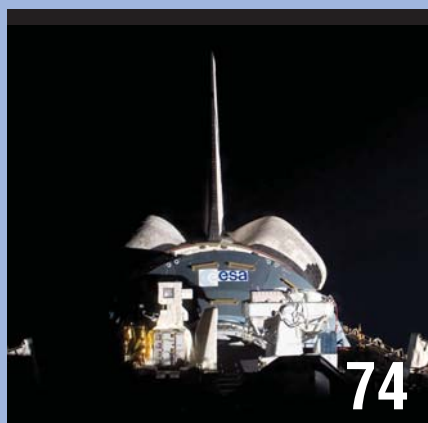

74

Dawn of a New Era
Columbus in Pictures

| | | | |
|---|----|--|----|
| One of ESA's Most Challenging Missions Yet | 2 | Europe's Eyes on the Skies | 42 |
| A Foreword | | The Proposal for a European Space Surveillance System | |
| <i>Volker Liebig</i> | | <i>Heiner Klinkrad et al.</i> | |
| GOCE: Obtaining a Portrait of Earth's Most Intimate Features | 4 | Welcome to Space | 50 |
| <i>Mark Drinkwater et al.</i> | | ESA's Strategy for Retaining European Space Competencies | |
| A Jewel in ESA's Crown | 14 | <i>Fiona Walsh et al.</i> | |
| GOCE and its Gravity Measurement Systems | | Programmes in Progress | 56 |
| <i>Michael Fehringer et al.</i> | | News – In Brief | 74 |
| GOCE's Measurements of the Gravity Field and Beyond | 24 | Publications | 88 |
| <i>Rune Floberghagen et al.</i> | | | |
| James Webb Space Telescope | 32 | | |
| A Bigger and Better Time Machine | | | |
| <i>Peter Jakobsen & Peter Jensen</i> | | | |

GOCE: One of ESA's Most Challenging Missions Yet

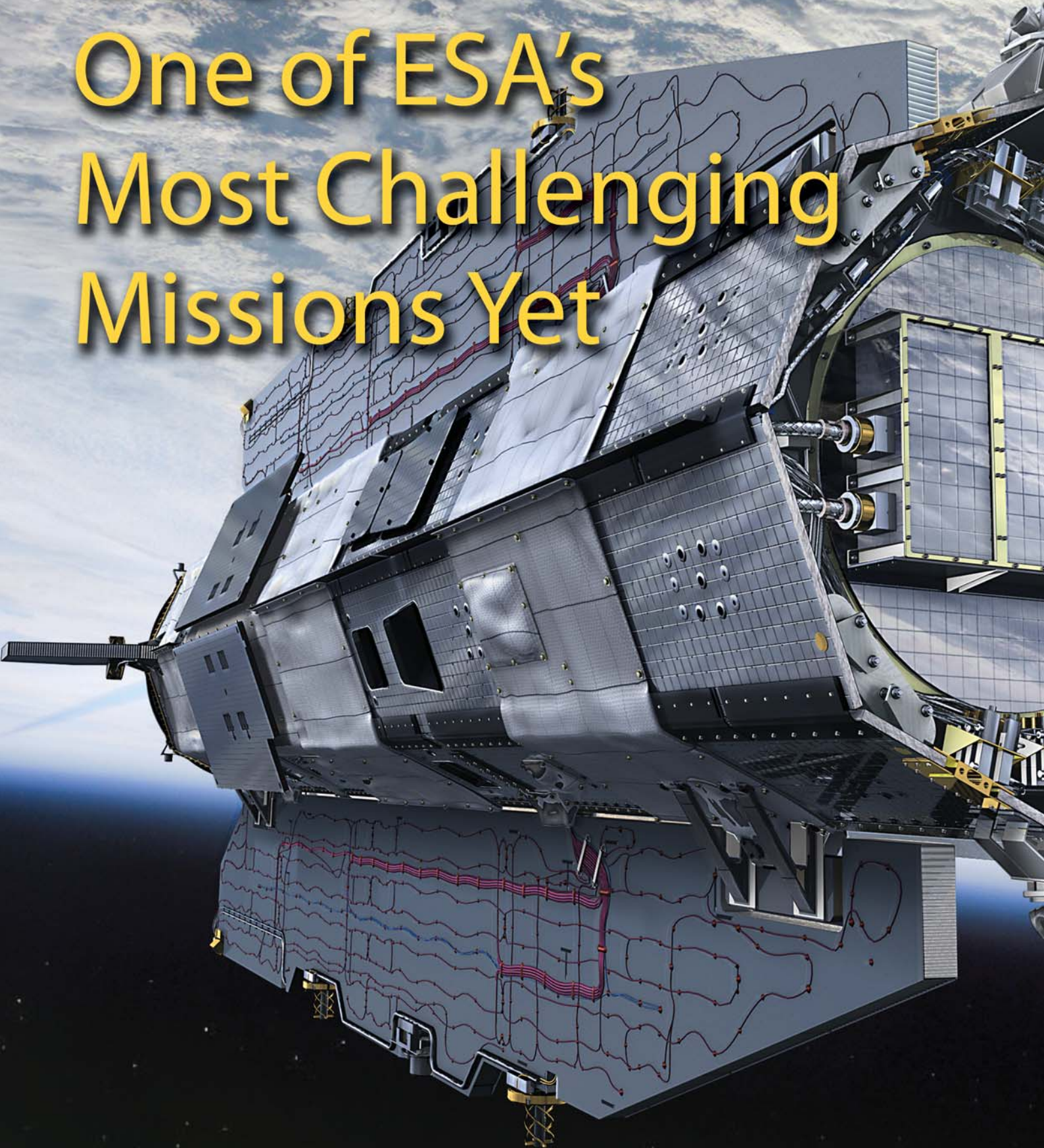

*A foreword by Volker Liebig
Director of Earth Observation Programmes
ESRIN, Frascati, Italy*

The launch of the Gravity field and steady-state Ocean Circulation Explorer (GOCE) constitutes a cornerstone for ESA's Earth Observation Envelope Programme. It will be the first satellite of the Earth Explorer family to be placed in orbit and its mission is to explore one of the most intriguing features of our planet: its gravity field.

ESA's fleet of Earth Explorers are the research missions of the Living Planet Programme. They focus on the key components of our planet, such as the geosphere, including Earth's interior, hydrosphere, cryosphere, atmosphere and biosphere. The aim is to make space-based global measurements to advance our understanding of the interactions between these components and the impact that human activity is having on natural Earth processes.

For instance, gravity is a fundamental force of nature that drives many dynamic processes within Earth's interior, and on and above its surface. This is because gravity is directly linked to the distribution of materials with different densities within Earth and to the distribution of waters and ice on its surface.

The GOCE mission will therefore advance our knowledge of Earth interior processes such as earthquakes and volcanism but also of ocean circulation, which plays a crucial role in energy exchanges around the globe, and sea-level change.

Consequently, GOCE data will be used by a wide range of scientific disciplines, such as geophysics, oceanography, glaciology and geodesy. This data will also have numerous practical applications; one of the most important will be the setting of a high-

accuracy planet-wide height reference system, useful for cross-border levelling and construction as well as for the comparison of sea levels all over the world.

In order to achieve its very challenging mission objectives, the GOCE satellite is based on cutting-edge technology, making it a jewel of innovations. GOCE will add a new entry in ESA's book of records. It is carrying a gradiometer in space for the first time, which is a unique instrument based on six ultra-sensitive accelerometers able to achieve amazing measurement accuracies.

Moreover, it has been designed to fly at an extremely low orbital altitude, just 250 km above Earth. For this reason it has an eye-catching aerodynamic shape and will actively compensate for the air drag by using the finely controlled thrust of an ion engine.

The development of the GOCE satellite by an industrial consortium of 45 companies, distributed over 13 European countries, is an outstanding example of what European cooperation can achieve. The same goes for the GOCE ground segment where, in particular, the European GOCE Gravity Consortium (comprising ten leading institutes and universities) will have the task of processing the data and generating an Earth gravity field model and associated geoid with unprecedented accuracy and spatial resolution.

The launch of GOCE this spring, followed by its measurement campaign, will be the deserved reward for the many efforts spent in ESA, industry and the scientific community in the preparation of this very challenging European mission.

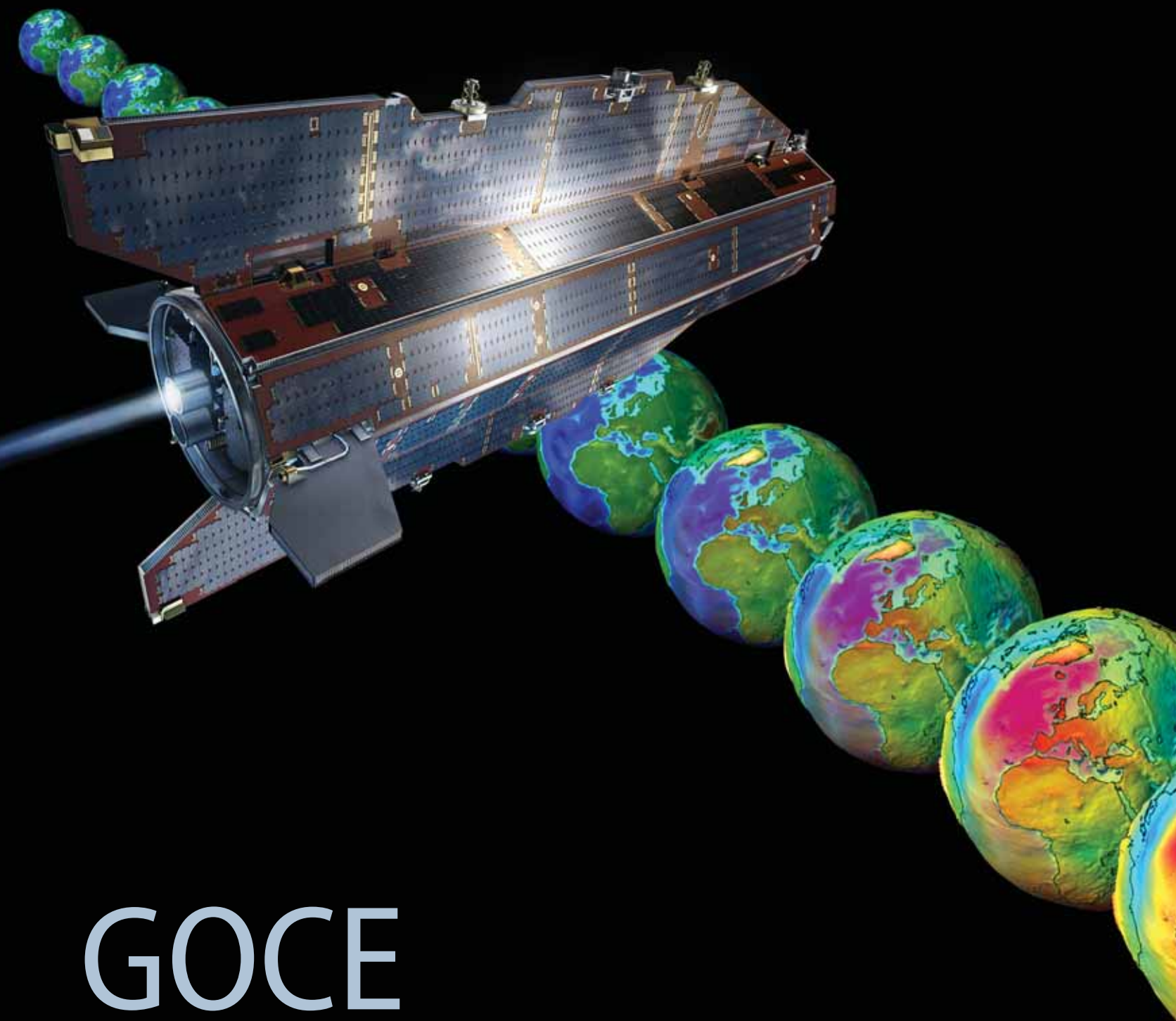

GOCE

Obtaining a Portrait of Earth's
Most Intimate Features

*Mark Drinkwater, Roger Haagmans
& Michael Kern*

Science, Applications and Future Technologies
Department, Directorate of Earth Observation
Programmes, ESTEC, Noordwijk,
The Netherlands

Danilo Muzi & Rune Floberghagen

Projects Department, Directorate of Earth
Observation Programmes, ESTEC, Noordwijk,
The Netherlands

Rune Floberghagen

Ground Segment Department, Directorate of
Earth Observation Programmes, ESRIN,
Frascati, Italy

Known as ESA's 'Gravity Mission', GOCE represents a blend of revolutionary new technology, designed to open a new chapter in what has historically been one of the most intriguing issues confronting science. Scheduled for launch in mid-2008, GOCE will deliver data about the fundamental force of nature, which will benefit a broad range of applications in Earth sciences.

Introduction

The Gravity field and steady-state Ocean Circulation Explorer (GOCE) is the first core mission in a series of six approved ESA Earth Explorers. GOCE embodies many firsts in terms of addressing the shape and characteristics of Earth's gravity field in unprecedented detail.

Although invisible, gravity is a fundamental and complex force of nature that has an immeasurable impact on our everyday lives. Gravity varies in an extremely subtle way from place to place on the surface of Earth and in space, due to a number of factors such as Earth's rotation, position of land masses, variations in the density of Earth and the redistribution of mass

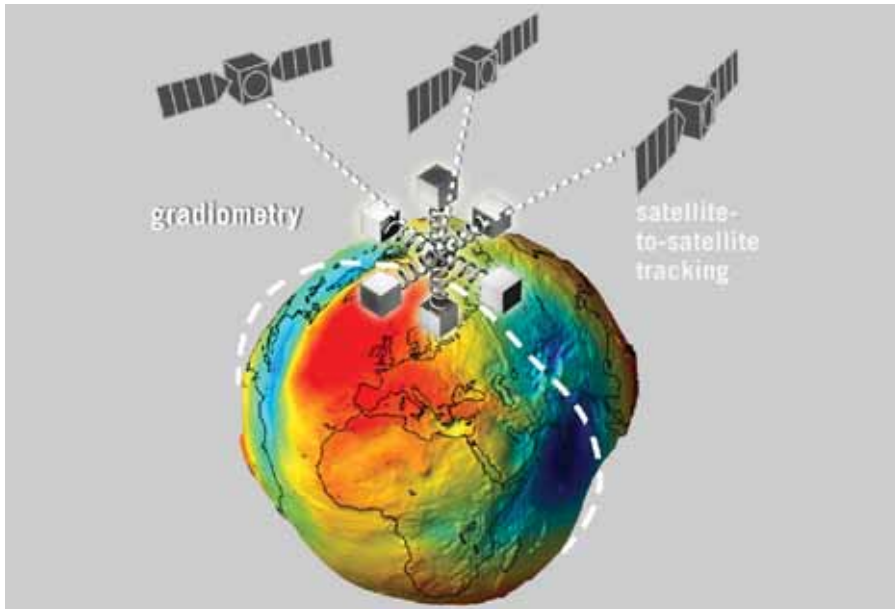

Illustration of GOCE concept, illustrating the gravity gradiometer sensor measurement principle and the high-low GPS satellite positioning as the satellite circles the geoid (AOES Medialab)

due to effects such as motions of the gaseous, fluid, or solid components of the Earth system.

A better knowledge of the gravity field is needed to provide more insight into Earth's interior, while a precise model of the geoid (a level surface defined by equal gravitational potential) as defined by the gravity field, is crucial to understanding more about ocean circulation.

The challenge of observing gravity is complicated by the fact that the average observable signal at the surface depends closely on the scale at which we wish to resolve details. The magnitude of the signal decays rapidly, considering the effects from large features to small ones (see Components of Earth's gravity). This makes it difficult to distinguish small-scale features in the presence of the primary terms of the gravity field.

The problem of measuring effects of local variations in gravity is further compounded by the fact that at satellite altitudes the scale-dependent signal is rapidly attenuated with distance above Earth's surface. This makes it challenging to determine Earth's gravity field from space, and it is particularly difficult to resolve small-scale features. Therefore, it is imperative to fly in an orbit as

low as is technologically feasible and to find a measurement technique to further counteract the altitude-dependent attenuation of gravity.

Principles of the Satellite Gravity Mission

Satellites in orbit behave according to the physics of Newtonian mechanics.

GOCE, specifically designed for the purpose of measurement of Earth's gravity field, will be launched into a Sun-synchronous near-circular orbit and will travel with a speed of around 8 km/s in order to remain in 'free fall'. The orbit will typically be inclined at several degrees off the pole such that Earth's equatorial bulge acts to rotate the plane of the orbit around Earth, at a rate that matches the motion of the Sun across the sky. The orbit will also be tuned to optimise the sampling pattern over certain intervals of time.

In this configuration, the basic ingredients required for a high-precision gravity mission are:

- global coverage with data of homogeneous quality;
- a gravity sensor based on the concept of a gravity gradiometer;
- a low orbit with accurate positioning and precise orbit determination by means of a Global Navigation Satellite System (GNSS);
- the effects of non-gravitational forces to be measured and/or compensated for;
- instruments providing knowledge of the orientation of the gravity sensor in space;

GPS satellite tracking is used to accurately determine the location of the spacecraft in its low Earth orbit, and the large-scale undulations in the satellite orbit trajectory in response to the gravity field (AOES Medialab)

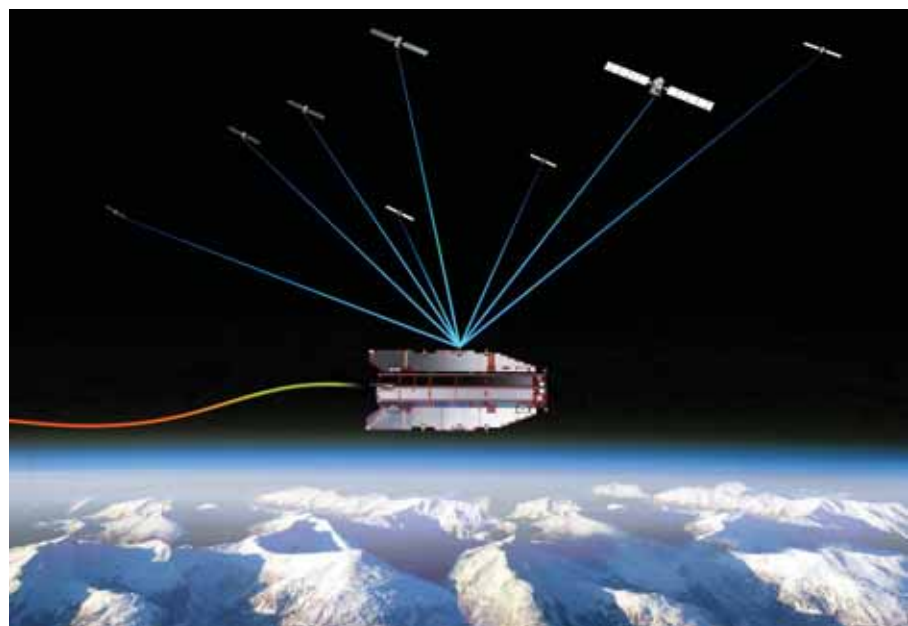

Components of Earth's Gravity



The primary constituents of gravity

The acceleration that a body experiences because of gravitation when it falls freely close to the surface of a massive body, such as planet Earth, is known as the acceleration of freefall. The value of gravity g experienced directly at the surface of Earth approximates to 9.8 m/s^2 , though the exact value depends on location. The primary contributions to g depend on several factors: the effects of

a spherical Earth is of order one, while that caused by Earth's rotation and equatorial bulge is of order $10^{-3} g$; mountains and ocean trenches result in the next largest constituent of order $10^{-4} g$; and further deviations of the actual field from an ellipsoidal model, together with internal mass distribution and other factors, result in variations the order of $10^{-5} g$ or less.

- ability to correct the signal contribution due to orbital rotation of the sensor;
- minimisation of self-gravitational forces, or signal contamination due to local platform noise.

In order to realise a precise measurement capability, the satellite together with its gravity sensor and system of supporting instrumentation and control elements, must be considered to form a single composite gravity-measuring device.

Mission Objectives

The GOCE single-satellite mission is dedicated to measuring Earth's gravity field and providing a model of the geoid with unprecedented accuracy and spatial resolution. The scientific community proposing the mission posed the primary challenges as measurement of Earth's gravity gradients in all spatial directions and accurate satellite orbit determination to an accuracy that will allow determination of:

- gravity field anomalies with an accuracy of 1 mGal (or 10^{-5} m/s^2),
- the geoid to an accuracy of $1\text{--}2 \text{ cm}$.

Both of these objectives should be met at a spatial resolution (i.e. half-wavelength scale) of 100 km or less with

global, regular and dense measurements of high and homogeneous quality.

GOCE is the first satellite mission to employ the concept of gradiometry. Satellite gradiometry is the measurement of acceleration differences over short baselines between proof masses of an ensemble of accelerometers inside a satellite. The GOCE gravity gradiometer contains six proof masses, each capable of sensing detailed local changes in acceleration in three dimensions with extremely high precision. With its ultra-sensitive accelerometers, the gradiometer instrument is capable of providing effects of gravitational origin. In this way, the effect of the altitude-dependent attenuation of Earth's gravitational attraction is counteracted.

Although the gradiometer is highly accurate, by itself it is not able to map the complete gravity field at all space scales to the required accuracy. Thus to overcome this limitation, the position of the GOCE satellite is tracked by GNSS satellites at an altitude of $20\,000 \text{ km}$ – a concept known as 'high-to-low satellite-to-satellite tracking'. Analysis of the

satellite motion in orbit yields gravity field information caused by large-scale phenomena. Complementary, the gradiometer is used to retrieve the high-resolution features of the gravity field.

The high spatial resolution achieved for the GOCE geoid model product is essential for the determination of stationary ocean dynamic topography in general, and particularly for high-resolution ocean circulation determination. In addition, its data will be useful for levelling by GPS, navigation, continental lithosphere studies and for global unification of height systems allowing, for instance, the establishment of a global sea-level monitoring system.

Benefits of GOCE Data

The GOCE mission will collect new data with which to make significant advances in the field of geodesy and surveying. These areas will benefit directly from the accurate gravity gradient products and the gravity and geoid model products derived from GOCE observations. These products will also be used to advance our knowledge of ocean circulation,

| Parameter | Requirement | | |
|--------------------------|-------------|-----------------|---------------------------|
| | Accuracy | Resolution (km) | Spherical Harmonic Degree |
| Geoid (m) | 0.01–0.02 | 100 | 200 |
| Gravity Anomalies (mGal) | 1.0 | 100 | 200 |



Modern local surveying tools, such as the spirit-level, simplify levelling on a small scale. But construction of early water-bearing structures, such as Roman aqueducts, relied on traditional levelling methods to transport water

which plays a crucial role in energy exchanges around the globe, sea-level change and Earth interior processes.

Land and Marine Surveying

The geoid is the classical reference surface for establishing physical levelling heights. It represents a surface along which no water flows from one point to another. Height systems on each

continent and island are connected and unified in principle by placing a reference benchmark for each of them on the geoid. Unfortunately, this situation does not exist. Traditionally, the local reference benchmarks have been tied to local mean sea level, resulting in up to a few decimetres differences between them. The GOCE geoid is expected to allow unification of

these systems on a global scale to within the resolution and accuracy of the model, which goes well beyond what exists today. This unification serves a number of purposes.

A unified height system would allow height systems to be connected across open water, such as lakes or ocean straits, easing tunnel or bridge construction projects. For example in the case of the Øresund bridge, crossing the Great Belt from Denmark to Sweden, there was a need to connect local height systems and to provide consistent and precise levelling over a distance of 22 km between the two countries. Such an application emphasises the need for precise topographic and gravimetric information. In addition, a unified height system would allow topographic height above sea level to be directly compared between for example the Mont Blanc in the Alps and Mount Everest in the Himalayas.

Furthermore, tide gauges basically recording locally relative sea-level changes can be made consistent with satellite altimetry data. The difference to the geoid allows a physical interpretation in terms of ocean dynamic topography and related currents.

Levelling versus GNSS Levelling

Classical levelling is an expensive and time-consuming field effort, and the user community would like to replace this

The Øresund bridge and tunnel system between Denmark and Sweden connected two national height systems



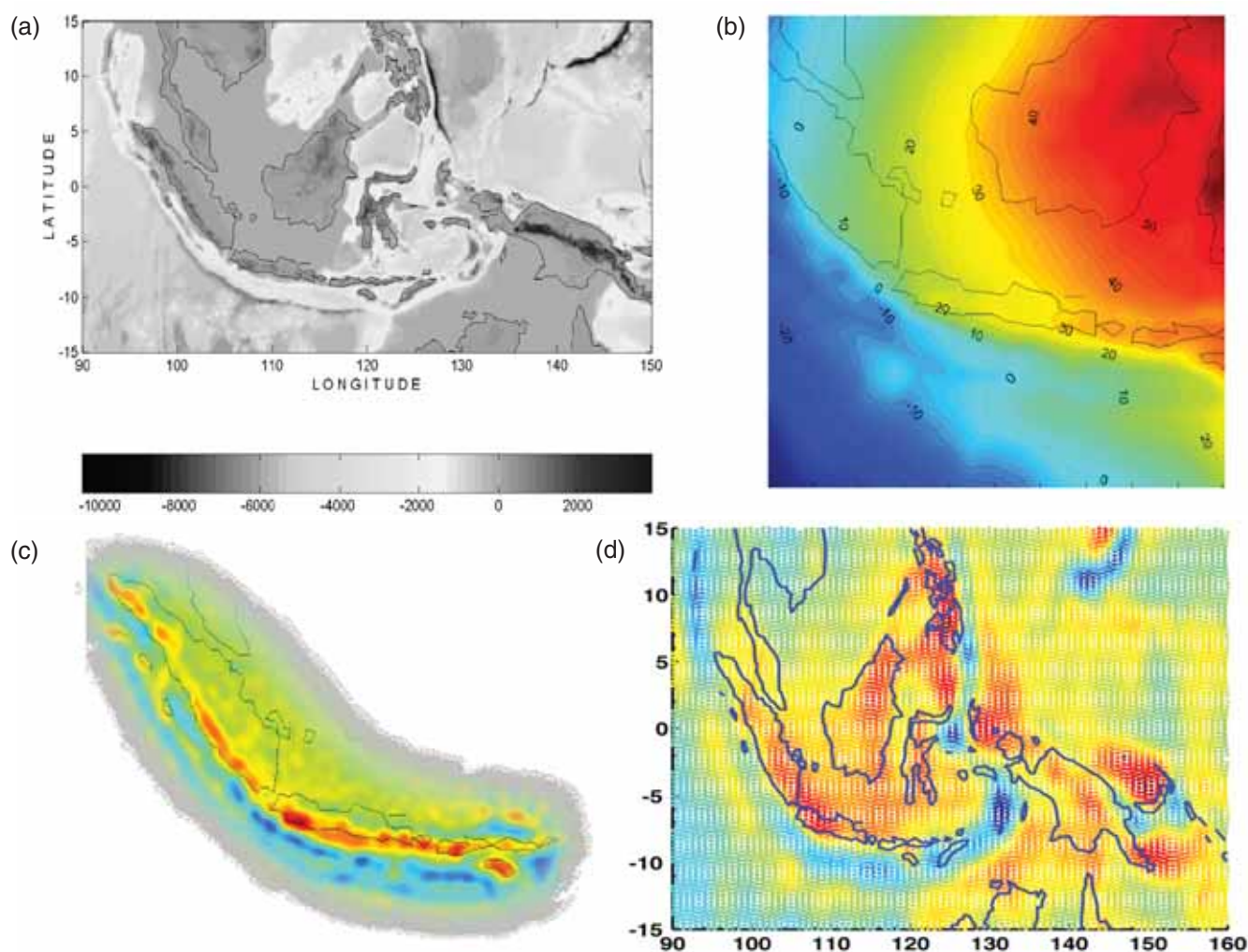

(a) Topography in the Indonesian archipelago; (b) global geopotential model of the region illustrating the coarse resolution, long-wavelength perspective offered by current satellite data; (c) in situ and airborne data providing high-resolution perspective of the local details of the gravity field; (d) simulated GOCE gravity gradient measurements of the same region

more traditional method by an indirect method. In a proposed new approach, GNSS geometric heights can be referenced to a geoid, from which physically meaningful levelling heights (known as ‘orthometric heights’) can be obtained. This requires a combination of the global geoid model from GOCE with regional gravity data to sufficiently small scales and with sufficient accuracy. In addition the GNSS height determination would need to be sufficiently accurate to be able to compete with the millimetre to centimetre accuracy of traditional levelling.

The same principle applies to the marine environment where GNSS-derived water-level heights of ships and depth-sounding data can apply the same geoid reference as the land data and the

tide gauges. The instantaneous sea-surface topography data from the GNSS water-level heights from ships relative to the geoid can then potentially be used to feed and improve continental shelf or coastal ocean models. This would in the future require sufficiently accurate GNSS height determination and fast communication links for transmitting the results to aid the models. These applications will directly benefit from the availability of GPS, GLONASS and Galileo positioning systems in the future.

Solid Earth Physics

Combination of GOCE gravity field information and seismic data is expected to provide a detailed mapping of density variations in the Earth crust

and the upper mantle, down to a depth of approximately 200 km. Satellite-derived gravity gradient data from GOCE will be especially useful for studies related to subduction zones where tectonic plates meet each other. Static density modelling and finite-element modelling can be used to study asperities in these subduction zones. New density models constrained by the GOCE satellite data will extend existing interpretations and provide new insight into frontier regions where little or no surface data exist. Examples are the relatively poorly understood regions such as Antarctica and the Himalayas.

A big advantage of GOCE data is that they provide global access to consistent gravity field information across all

natural or artificial boundaries and, importantly, also in areas that are difficult to access. Methods need to be developed to fully exploit the potential of the new gradient data in geophysical applications. The resolving power of the satellite gravity information – potentially complemented with ground data – must also be quantified in order to ascertain the degree to which the satellite data resolve crust and mantle structures. The satellite and ground data can be compared to predictions from existing 3D density models that are currently based upon seismic and terrestrial gravity data. In addition, the satellite data can be tested against the gravity field predicted by independently determined density models that are based upon new petrologically and thermodynamically based methods. A highly accurate satellite data set from GOCE will also help to improve regional investigations (e.g. in the area of exploration geophysics) by providing a reliable and accurate boundary condition.

GOCE will also further our knowledge of land uplift due to post-glacial rebound by improving the initial value of the viscosity of the mantle. This process describes how Earth's crust is rising a few cm per year in Scandinavia and Canada as it has been relieved of the weight of thick ice sheets since the last Ice Age, when the heavy load caused the crust to depress. In connection to this there is a global redistribution of water in the oceans as a consequence of past and present ice melt with typical effects of fall of sea level close to the location of the original ice caps and rise further away. A better understanding of these processes helps assessing the potential dangers of present-day sea-level change.

Ocean Circulation

The geoid surface mapped by GOCE will provide a global reference surface for oceanography applications. The geoid represents the shape that the ocean surface would take in response to variations in Earth's gravity, were the ocean to be motionless. Ocean currents cause gradients and topographic

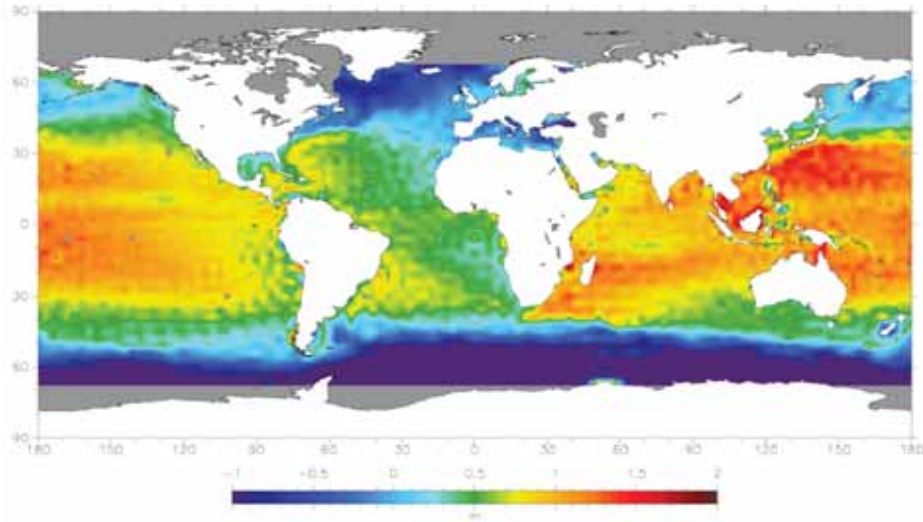

Ocean dynamic topography variations with respect to the latest geoid (CLS)

The first Earth Explorer core mission

The GOCE mission concept was first proposed and considered at the first Living Planet Programme User Consultation Workshop held in Granada, Spain in May 1996, along with eight other candidates. The measurement principles exploited by GOCE already had a long history and the concept was conceived in large part in prior preparatory studies for the Solid Earth Science and Application Mission for Europe (SESAME) in the 1980s, and subsequently the ESA Aristoteles mission concept.

On completion of the 1996 Granada Workshop, recommendations for four missions were made by the ESA Earth Science Advisory Committee (ESAC) from the nine candidates. The Earth Observation Programme Board (PB-EO) subsequently considered the ESAC recommendations and endorsed the selection of GOCE for study.

A Mission Advisory Group (MAG) was established to support ESA with advice during pre-Phase A concept assessment studies, and to oversee supporting scientific studies. The MAG members were tasked with establishing scientifically driven performance requirements in the form of a mission requirements document. In July 1998, a Phase A design feasibility study was initiated with industry on the basis of the resulting system requirements.

At the end of this study in July 1999, a final Report for Mission Selection (ESA, 1999) was drafted and presented at the second User Consultation Workshop in Granada, Spain in October 1999. GOCE was one of two core Explorer missions to be recommended by ESAC for selection. The PB-EO subsequently endorsed the ESAC recommendation in November 1999 and authorised ESA's proposal to begin GOCE implementation as the first Earth Explorer mission.

variations in the ocean surface that can be measured by existing ESA ocean altimeter systems such as RA on ERS-2, RA2 on board Envisat, or the future GMES Sentinel-3 SRAL. It is therefore

the combination of sea-surface topographic mapping by altimeters and the precise ocean geoid that give access to essential details of the ocean circulation patterns at length scales of 100 km.

Mean sea-surface heights (cm) measured by altimeter systems are accumulated and converted to topography by expressing the ocean surface variations relative to the geoid. Variations in sea-surface topography are typically between -1 m (deep blue) and $+1$ m (light blue) relative to the geoid. This sea-surface shape, known as the dynamic topography, is related to large-scale ocean currents and is characterised by prominent regional variations expressed in the form of elevations and depressions.

Importantly, the large-scale current systems flow along the lines of equal topography and are focused around the strongest gradients in sea-surface height. In the northern hemisphere, the flow is clockwise around elevated ocean surface regions, due to the well-known Coriolis effect caused by the rotation of Earth. In the southern hemisphere, the flow is counter-clockwise around high elevations. Global maps of the dynamic topography reveal the primary features of the general circulation. Ocean gyres and associated major currents are highlighted, as is the major Antarctic Circumpolar Current which links together all of the major ocean basins in the southern hemisphere.

One of the main benefits of having access to a $1\text{--}2$ cm geoid is that the variability in the ocean currents may be characterised in conjunction with either existing or future altimetry data. The world's oceans exhibit many movements and variations which are more vigorous in some regions than in others. The strongest currents are observed near the western seaboard of the oceans, such as the Gulf Stream in the North Atlantic, the Malvinas Current in the South Atlantic, the Kuroshio Current near Japan and the Agulhas Current in the Indian Ocean south of Madagascar. These are also the zones in the ocean where the strongest transports of heat and salt are exhibited.

Presently, the degree to which altimetry data can be used to make precise estimates of the transport of heat, salt and freshwater, is limited by

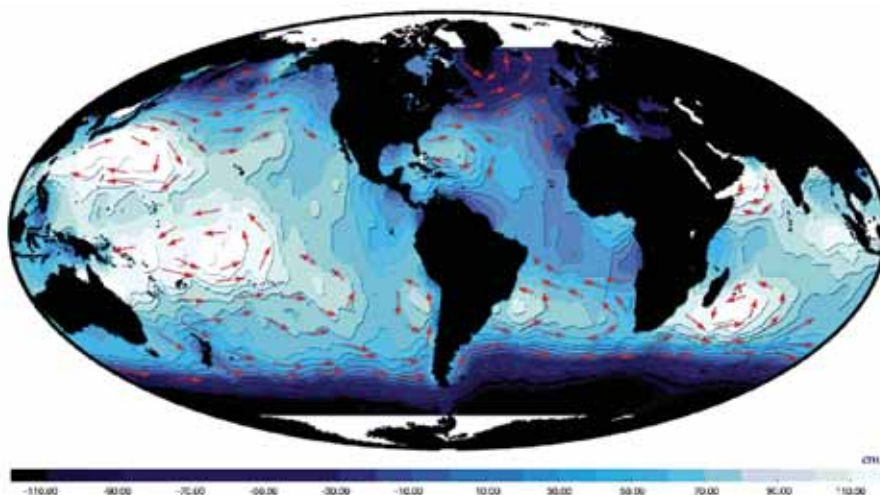

Large-scale patterns in ocean currents (red arrows) in relation to dynamic topography as observed by satellite altimetry (CLS)

Gravity missions in a wider context

Starting in 2000, satellite gravity field recovery entered the international 'geopotential decade' with the launch of a series of three complementary missions dedicated to gravity field recovery. These missions are CHAMP, GRACE and GOCE.

CHAMP

The CHAMP satellite mission was launched in July 2000. It combines gravity field determination with magnetic field measurements and atmospheric sounding. For the gravity field, CHAMP is equipped with a GPS positioning system and micro-accelerometer at its centre of mass. Together these instruments allow gravity derivation from continuous three-dimensional tracking of the spacecraft relative to GNSS satellites, and 3D accelerometer measurement of the non-gravitational forces on the satellite. CHAMP is descending slowly from an initial altitude of 454 km and its data over time have significantly contributed to improving our knowledge of the characteristics of the static gravity field at larger scales by providing homogeneous sampling and quality and by covering the polar regions. The mission has exceeded its nominal mission lifetime of five years, and continues to acquire good quality data.

GRACE

The GRACE twin-satellite mission was launched in March 2002. GRACE has the objective of determining temporal variations (i.e. on monthly, seasonal and interannual timescales) in Earth's gravity field, together with further refinement of the static component at medium spatial scales. It uses two identical satellites in the same orbit separated by approximately 220 km. The relative motion and distance between the two satellites is measured with a precision K-band microwave ranging radar system. Meanwhile, each satellite is equipped with a GPS positioning system and a micro-accelerometer at its centre of mass, allowing continuous 3D tracking of the spacecraft relative to GNSS satellites and 3D accelerometer measurement of the non-gravitational forces on each of the satellites. The GRACE system has been tailored successfully to obtain best possible measurement precision at large and medium spatial scales, in order to be able to recover time-variable gravitational signals.

Short History of Knowledge of Earth's Gravity

2nd century BC – 2nd century AD

The first rudimentary model of our Universe was constructed between the Greeks Aristotle and Plato, and Ptolemy. This early model contained the movements of the planets in relation to star locations, together with the motions that the Sun and Moon appear to trace around Earth. Ptolemy collected these ideas and formulated a series of circles or 'epicycles' that characterised the movements of the planets around Earth.



Ptolemy

Aristotle

Plato

16th century

Nicolaus Copernicus succeeded in greatly simplifying the concepts of Ptolemy, putting the Sun in its rightful place at the centre of the Solar System, but few appreciated the value of his work until after his death.



Copernicus

17th century

A combination of the ideas of astronomer Tycho Brahe and mathematician Johannes Kepler led to a breakthrough. Their collaboration led to a description of the orbits of the planets around the Sun, including the notion that the orbits need not be perfectly circular. The age of planetary orbital theory had begun.



Brahe

Kepler

1638

During the mid 17th century, the physicist Galileo Galilei unwittingly began to work on the opposite side of the same problem, gravity. By conducting experiments describing the Earthly effects of gravity on objects falling from a tower, Galileo was able to formulate theories describing the results and publishing his book *Two New Sciences*.



Galilei

Late 17th century

With supposed inspiration from a falling apple, physicist Isaac Newton finally unified the theories of planetary motion and an understanding of the force of gravity with his description of the laws of motion. He understood that

there was a force that was pulling heavy objects towards the centre of Earth and that the magnitude of this force depended on the distance from the centre. Through conversations with colleagues Hooke and Halley, Newton was able, together with the aid of Kepler's ideas about planetary motion around the Sun, to formulate an inverse square law that causes a body to move on an ellipse around the Sun. He wrote a document '*On the Motion of Bodies in Orbit*' in which he defined quantity of matter as mass, and quantity of motion as the product of velocity and mass.



Newton

1686

Newton wrote his first volume of the book *Philosophiæ Naturalis Principia Mathematica* in which he established that there is a force of attraction between masses called gravity. Newton for the first time established relationships between the forces acting on a body and the motion of the body. Today these laws form the basis for classical mechanics and are used to explain many results concerning the motion of physical objects. In his third volume, he showed that these laws of motion, combined with his law of universal gravitation, explained Kepler's laws of planetary motion.

Early 20th century

Hungarian physicist Loránd Eötvös, inspired by Newton's work, studied the gravitational gradient on the surface of Earth. An instrument, called torsion balance, was developed to measure local effects of the spatial changes in gravity field. His idea has been an inspiration for proposing airborne and satellite gravity gradient measurement concepts since the late 1960s and even Einstein cited Eötvös' work on weak equivalence principles in his 1916 *The Foundation of the General Theory of Relativity*. To exploit Einstein's ideas for gravity field determination from space would require further advances in technology. Newton's theory, together with Eötvös work on gravity gradients, form the basic concepts used in the satellite mission GOCE for mapping the gravity field of Earth.



Eötvös

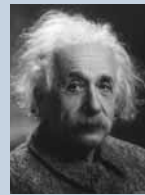

Einstein

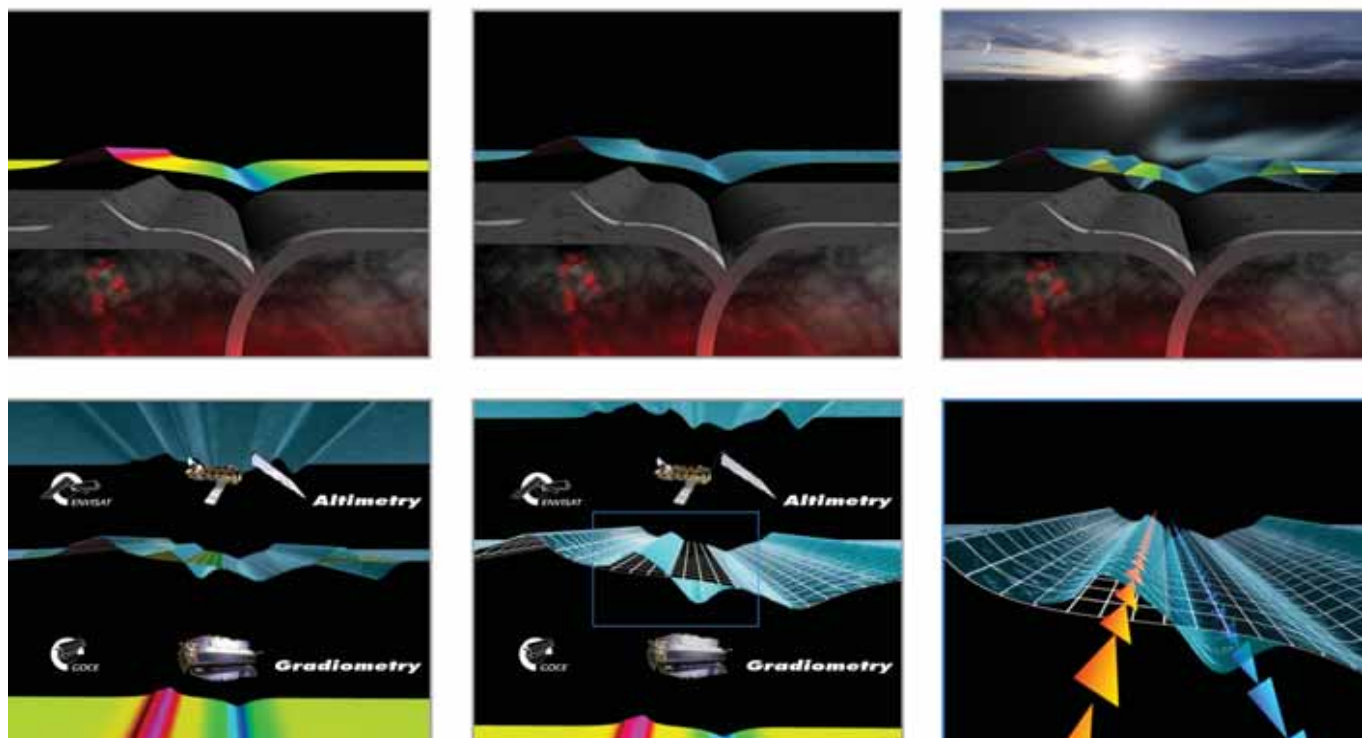
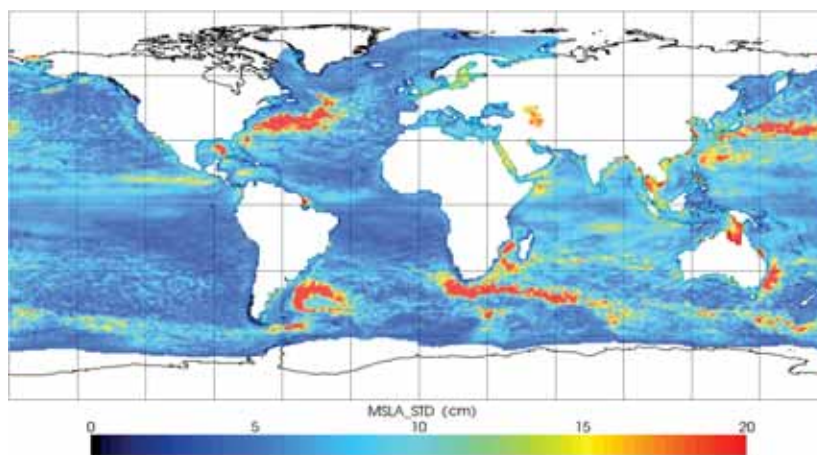

Illustration of (left to right, upper row): gravity field anomalies in response to crustal and interior density variations; the geoid or surface representing the ocean at rest; dynamic topography forced by winds and temperature variations. Lower row (left to right), the respective elements of the system measured by the altimeter missions and the GOCE mission; in central and right panels, the enlarged difference between the geoid grid and the altimeter-measured ocean topography gives access to information about ocean currents (AOES Medialab)

the quality of the geoid at short length scales. In order to properly measure these transports, the strong sea-surface gradients and the sea-surface height variations, caused by eddies or vortices generated by instabilities, must be properly captured. Height variations in the vicinity of these currents, caused by eddies tens or hundreds of kilometres across, can be as much as 0.3 m.

The Antarctic Circumpolar Current is another highly energetic current unbounded by any continent across which there is a significant gradient in ocean topography. Our present estimates of the extent to which it participates in transporting and exchanging water masses around the globe is similarly limited by the knowledge of the details of the geoid.

Given the exciting possibility of the new 1–2 cm geoid from GOCE, global satellite altimetry data records spanning the last 15 years can be used to provide a detailed retrospective picture of these ocean variations, and their conse-



Standard deviation computed from 12 years of altimetry data (all available satellites during the 1992–2004 period) (Aviso)

quences for the global freshwater and energy cycles.

Summary

The GOCE Earth Explorer mission is poised to open a new chapter in the pursuit of a greater understanding of Earth's gravity. Perhaps most importantly, the succession between CHAMP, GRACE and GOCE gravity missions in

this geopotential decade will lead to many benefits in terms of their significant cumulative and combined contributions to Earth system sciences. GOCE nonetheless represents a unique scientific contribution in this succession, striving for ultimate performance in an orbit previously untried by ESA Earth observation missions.

A Jewel in ESA's Crown

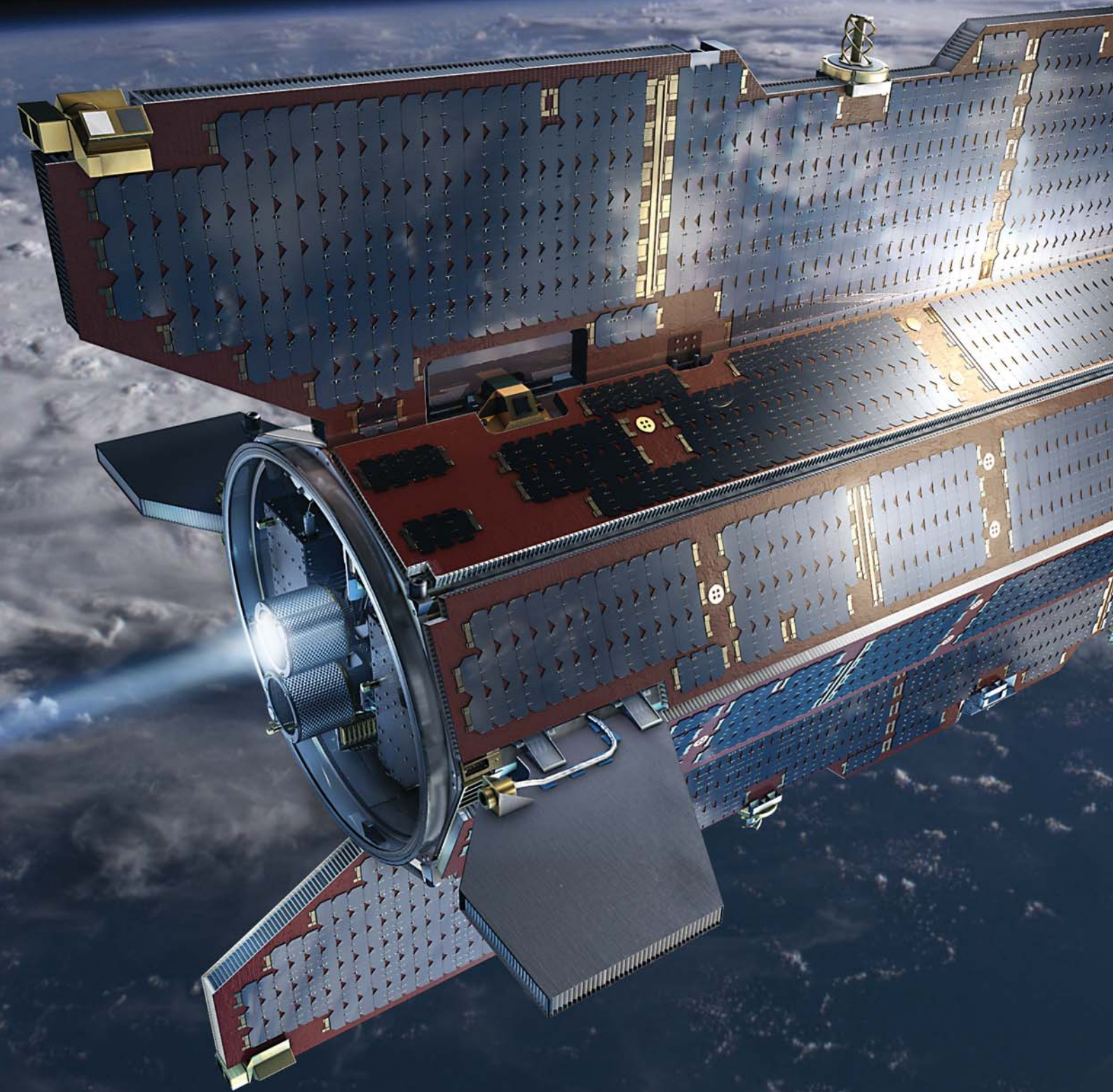

*Michael Fehringer, Gerard Andre,
Daniel Lamarre & Damien Maesli*
Directorate of Earth Observation Programmes,
ESTEC, Noordwijk, The Netherlands

It's elegant and aerodynamic design catches your eye. It is designed to fly as low as 250 km, putting great demands on its thermal and mechanical stability. It uses an ion engine to compensate constantly for atmospheric drag to keep it in orbit. This is GOCE, the 'Ferrari' of gravity field measurement satellites.

One of the main problems with observing gravity from space is that the strength of Earth's gravitational attraction diminishes with altitude. The orbit of the satellite must therefore be as low as possible to observe the strongest possible gravity field signal. On the other hand, the measurement environment provided by the satellite needs to be extremely quiet and ideally free of non-gravitational forces.

These two requirements drove the design for the GOCE spacecraft and its mission implementation. As a best compromise, a 270 km altitude Sun-synchronous orbit was chosen for the initial science measurement phase. Two measurement phases with a maximum duration of six months each are planned during the mission.

GOCE and its Gravity Measurement Systems

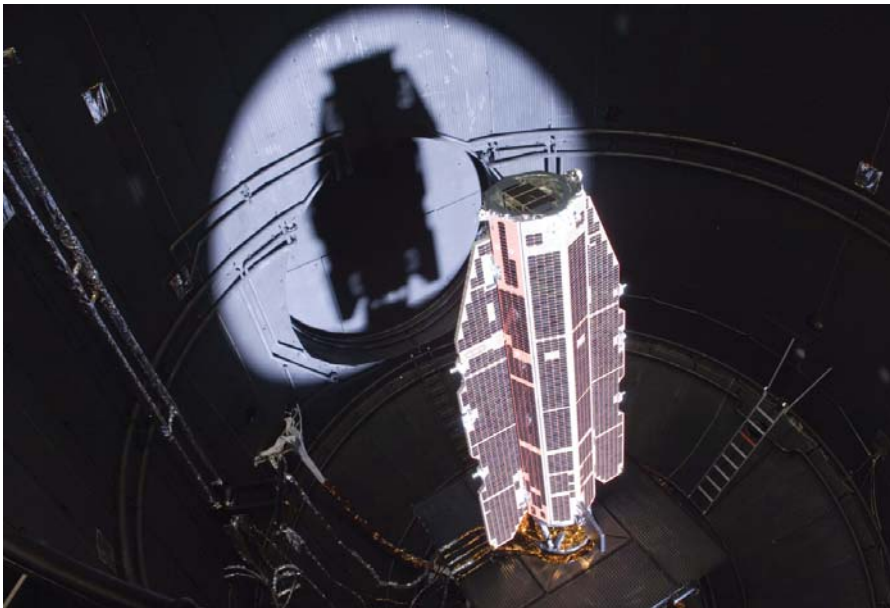

GOCE inside the Large Space Simulator test chamber at ESTEC

ESA's 'quiet mission'

These specific needs could only be satisfied by assembling a number of novel technologies, including various 'firsts' and making GOCE a technological masterpiece. These technologies include drag-free-control, electric propulsion, electrostatic gravity gradiometry, triple junction GaAs solar cells and the manufacturing of large, 3D carbon-carbon honeycomb structures. A strict screening of all parts that could potentially cause micro-disturbances has been conducted.

The main instrument on GOCE is the Electrostatic Gravity Gradiometer (EGG). The EGG consists of six capacitive accelerometers arranged orthogonally in pairs at a distance of 50 cm, each pair forming a gradiometer arm. The difference in the accelerations measured by the two accelerometers belonging to the same arm is the basic scientific product of the gradiometer.

During a period of 200 seconds, the structure of that arm has to be stable to less than the diameter of an atom to achieve the required sensitivity. Half the sum of the accelerations measured by the accelerometers of one arm is representative of external, non-gravitational forces. This information is

used to continuously counteract (in closed loop) the atmospheric drag via an electric propulsion system. The GOCE satellite is flown in drag-free-control in the in-flight direction.

Although the gradiometer is highly accurate, it cannot map the complete gravity field at all spatial scales with the

GOCE industrial consortium

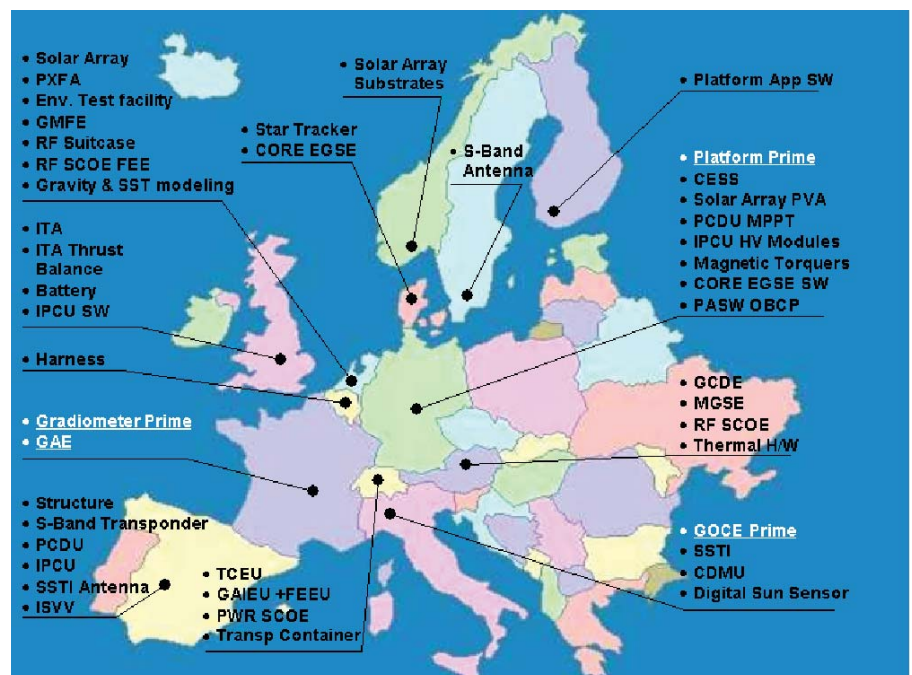

same quality. To overcome this limitation, GOCE is equipped with a second payload, the Satellite-to-Satellite Tracking Instrument SSTI, a state-of-the-art GPS receiver. By exploiting very precise orbit determination based on SSTI data allows obtaining the long wavelength spectrum of the gravity field whereas the EGG provides the short spatial scale components. As with the EGG, the SSTI also acts as a sensor for the orbit control system by providing an on-board real-time navigation solution.

The GOCE Satellite

The need for low, quiet flight means the design must minimise air drag forces and torques, and eliminates mechanical disturbances. The result is a very slim satellite with a cross-sectional area of 1.1 m², 5.3 m in length and weighing about 1000 kg. The satellite is symmetrical about its flight direction and two winglets provide additional aerodynamic stability. Once in orbit, the same side of the satellite will always face the Sun. The satellite is equipped with four body-mounted and two wing-mounted solar panels that use triple junction GaAs solar

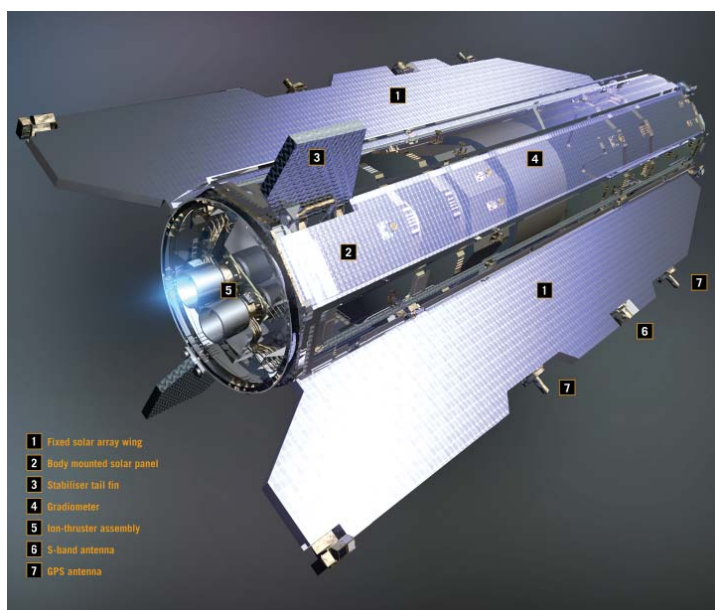

Artist's view highlighting the electric propulsion and other subsystems

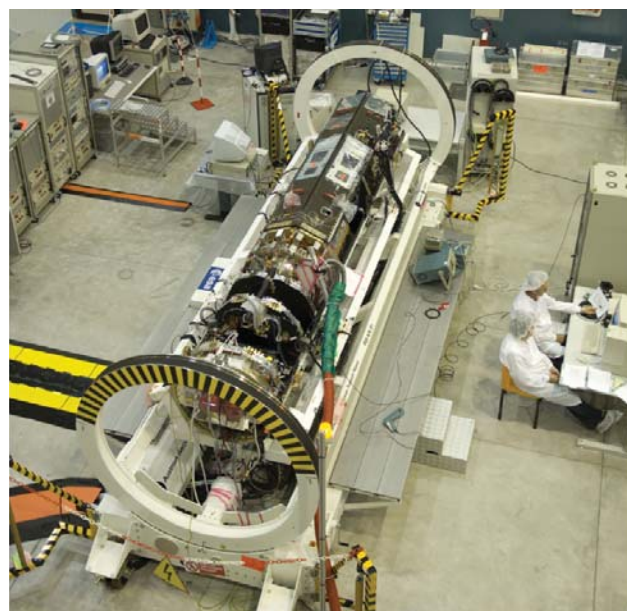

View of instruments without covering panels

cells. One S-band communication antenna is mounted on each wing; one points upwards and one downwards so that full spherical coverage is granted. The wing pointing towards space carries two GPS antennas.

The satellite consists of a central tube with seven internal floors that support the equipment and electronic units. Two of the floors support the gradiometer, mounted close to the satellite's centre of mass. The spacecraft structure is largely built of carbon-fibre reinforced plastic sandwich panels to guarantee stable conditions under varying thermal loads and at the same time to minimise its mass.

Thermal control is achieved by passive means and it is designed to be able to cope with eclipses lasting up to 15 minutes during measurement phases and up to 30 minutes in survival mode. Due to its unprecedented temperature stability requirements in the few milli-degrees Kelvin range, the gradiometer is thermally decoupled from the satellite and has a very special thermal control concept. An outer, actively controlled thermal domain is kept at a very stable temperature by heaters and is separated by blankets from an inner passive domain that provides an extremely

homogeneous environment for the accelerometers. The temperature must be stable to within 10 milli-degrees for a period of 200 seconds. The side facing away from the Sun is mainly used as a radiator. All external surfaces are protected against atomic oxygen.

The Electrostatic Gravity Gradiometer (AOES Medialab)

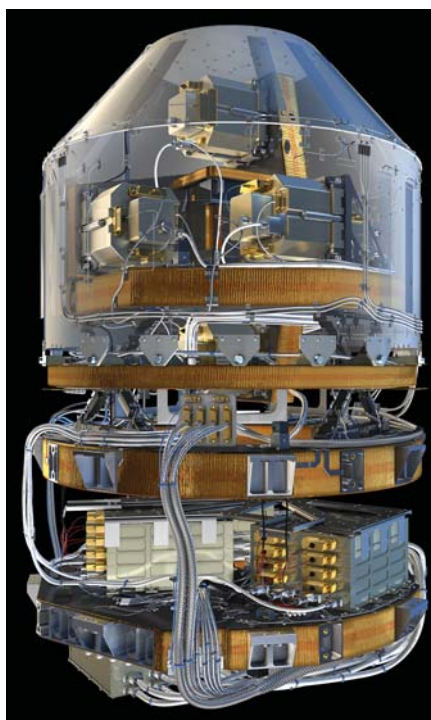

GOCE was built by an all-European industrial consortium. The prime contractor is Thales Alenia Space Italy, with Astrium Friedrichshafen responsible for the platform and Thales Alenia Space France and ONERA for the gradiometer. About 40 other contractors are involved, see the figure opposite.

The Electrostatic Gravity Gradiometer (EGG)

EGG consists of three pairs of capacitive accelerometers mounted on an ultra stable carbon-carbon honeycomb support structure. The principle of operation of one of these accelerometers is that a proof mass is floated in a small cage and is kept in the centre of the cage by electrostatic forces, i.e. by applying voltages between the cage and the different sides of the parallelepiped shaped mass. These voltages are representative to the accelerations seen by the proof mass and are the initial input to a long chain of investigatory steps that, for example, will ultimately determine where the water in the oceans flows.

The requirements on the gradiometer are unique. The accelerations measured by each accelerometer can be as small as one part in 10 000 000 000 of the gravity experienced on

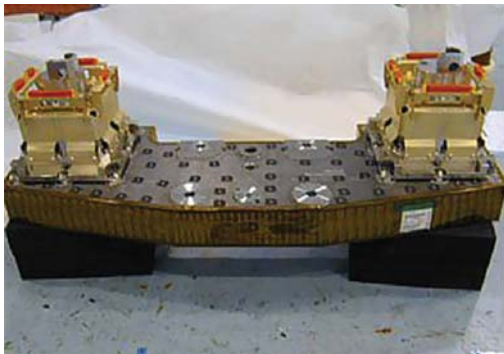

Gradiometric arm with two accelerometers mounted on an ultrastable carbon-carbon structure

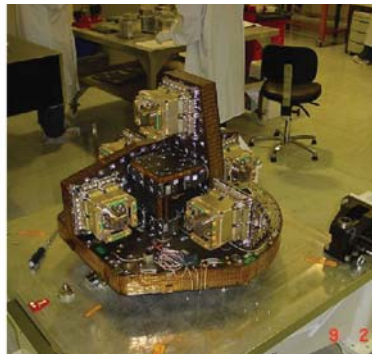

Gradiometer core consisting of three orthogonally mounted pairs of accelerometers

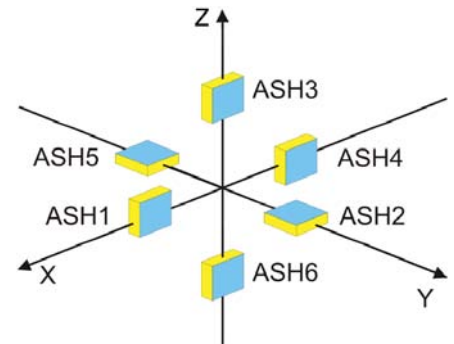

Flight configuration of the six individual accelerometers. X indicates flight direction, Z is pointing radially away from Earth

Earth. The GOCE accelerometers are about 100 times more sensitive than any accelerometers previously flown. The distance between each sensor pair must not vary by more than 1% of an Ångström (the diameter of an atom!) over a mean time interval of about three minutes. This can only be achieved by using the 3D carbon-carbon structure.

Two accelerometers of the same pair are mounted at 50 cm distance to each other and form a ‘gradiometric arm’. The two proof masses of the same pair have the tendency to move towards or away from each other under the influence of Earth’s gravity field. The gradiometer measures this movement.

Because the pull of Earth, or in other words the acceleration of the masses, is very weak and subject to noise or forces other than gravity, the method of differential measurement is used. The results from two accelerometers in one arm are subtracted from each other, removing noise and disturbing forces that affect both accelerometers. This is called ‘common mode rejection’. What remains is the difference in acceleration due to Earth, measured at two locations separated by 50 cm. This difference is also called the ‘gravity gradient’ and is the main scientific product of GOCE.

In addition to the differential measurement, the average acceleration of two measurements in one arm is also exploited. This average is representative of external forces on the spacecraft like atmospheric drag and solar radiation pressure. This information is used to

command the electric propulsion (ion) engine to continuously counteract the atmospheric drag and keep the satellite flying undisturbed and drag-free.

The three gradiometric arms are arranged at 90° to each other so that the gradients are obtained in all three dimensions. The result of a science measurement phase is a gravity gradient map evenly covering our planet except for small areas around the poles.

The proof masses are made of bulk platinum-rhodium alloy with a dimension of 4 cm by 4 cm by 1 cm. This shape allows the accelerometer to be tested on ground by applying high voltage on the electrodes on the larger sides of the proof mass in order to electrostatically levitate the mass and so compensate for its weight. In spite of this sophisticated instrumentation, it is not possible to achieve on ground the complete verification of the sensitivity of the accelerometers. To advance confidence the GOCE accelerometers were also all tested in freefall at the ZARM drop tower in Bremen.

Accelerometer proof mass

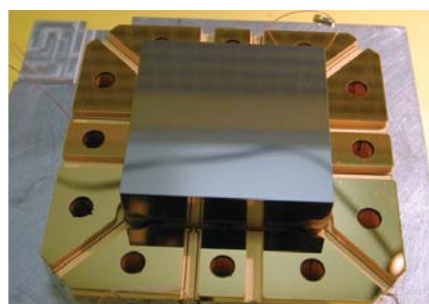

The disadvantage of the adopted proof mass geometry is the lower accelerometer sensitivity in one direction. This means that the GOCE accelerometer has two ultra-sensitive axes and a less sensitive axis. The in-line direction of each accelerometer is the most important one, and is covered by ultra-sensitive axes. The directions of the remaining ultra-sensitive axes have not been randomly selected. They have been chosen to lie in the XZ plane to maximise the sensitivity of the determination of the angular accelerations about the Y-axis, see the figure above. This angular rotation is indeed the most important in the gravity gradient determination, because it has a large constant component due to the rotation of the spacecraft itself.

EGG in Attitude and Orbit Control

The EGG has a double role. It is providing the gravity gradient measurements and it is also used as a main sensor in the attitude and orbit control system (AOCS). If this common mode acceleration in flight direction is not zero, the AOCS will respond by either increasing or decreasing the ion engine thrust to maintain the spacecraft in near-freefall conditions.

The gradiometer provides very sensitive measurements of the three linear and the three angular accelerations of the spacecraft, the three in-line gravity gradient components which are the objective of the scientific measurement, and of one off-diagonal

| | |
|---|---|
| Mass: | 180 kg |
| Power: | 100 W |
| Distance between accelerometers: | 0.5 m |
| Bandwidth as AOCS sensor: | DC to 5 Hz |
| Gravity measurement bandwidth: | 5 mHz to 100 mHz |
| Accelerometer Sensitivity: | 2×10^{-12} m/s ² $\sqrt{\text{Hz}}$ |
| Structure stability: | 0.2 ppm/K |
| Temperature stability: | 0.01°C over 200 s |

Characteristic gradiometer parameters

gravity gradient term (the one in the XZ plane). The two remaining off-diagonal gravity gradient terms are estimated with much lower sensitivity.

Gradiometer In-Flight Calibration

To reach a performance that is limited by the intrinsic fundamental noise of the instrumentation, the six accelerometers of the gradiometer must be well-aligned with each other and have the same gain and phase (electrical delay) in converting an acceleration into an output voltage. In total, 72 parameters define, in the gradiometer frame, the positions of the accelerometers, the orientations and the gains of all sensitive directions. These 72 parameters have to be calibrated in flight. In addition, the response of the accelerometer is not perfectly linear. The output voltage is not simply equal to the input acceleration multiplied by a scale factor. This non-linearity is best characterised and nulled in flight rather than characterised and processed afterwards on the ground.

The measurement of the accelerometer non-linearity is performed at accelerometer level, by injecting into the control loop of the relevant axis a modulated high-frequency signal, in effect 'shaking the test mass'. The output signal is then proportional to the modulation signal and to the quadratic factor. Nulling of the non-linearity is then achieved by offsetting the proof mass along the relevant axis. This process of characterising and nulling the quadratic factor is repeated a few times until the desired accuracy has been achieved.

The characterisation of the misalignments and scale factors cannot be done at gradiometer level. Here the complete spacecraft is being 'shaken'. Excitation along the X-axis is achieved by the modulation of the ion thruster. Excitation of the other five degrees of freedom is achieved by activation of eight cold gas thrusters specially implemented for this calibration function. The in-flight calibration takes about 24 hours and is expected to be repeated every month.

Satellite-to-Satellite Tracking Instrument (SSTI)

The SSTI is a state-of-the-art GPS receiver that has been designed to operate in a low-Earth orbit environment. It can simultaneously track 12 GPS satellites and works on L1/L2 frequencies. This eliminates errors caused by the ionosphere, which extends between the

Characteristic SSTI parameters

| | |
|--|------------------------|
| Mass: | 6.1 kg (incl. antenna) |
| Power: | < 35 W |
| Performance (at 1 Hz): | |
| - Real time position (3D, 3 σ) | < 100 m |
| - Real time velocity (3D, 3 σ) | < 0.3 m/s |
| - time (1 σ): | < 300 ns |
| - L1/L2 carrier phase (anti-spoofing on): | < 3.55 mm / < 17.22 mm |
| - L1/L2 P-code (anti-spoofing on): | < 1.9 m / < 1.9 m |
| - L1 C/A-code: | < 0.92 m |
| - Inter-channel bias (carrier phase/code range): | 0 mm / 0.4 mm |
| - Inter-frequency bias: | < 10 mm |
| - Phase centre knowledge accuracy (L1/L2): | 1.84 mm/2.35 mm |

GOCE and the GPS orbits. In the case of GOCE, the GPS receiver is located on the satellite instead of on ground: the receiver is moving at a considerable speed with respect to the GPS satellites. The received signals are thus affected by a Doppler shift, the same way as the pitch of the noise of a passing train.

The SSTI provides both science data and real-time information on spacecraft position and velocity. The latter is used on board for orbit and attitude control.

The SSTI receiver uses a hemispherical-coverage quadrifilar helix antenna. Due to the targeted POD performance, the SSTI antenna design and performance verification have been very challenging. The SSTI antenna was first tested in an anechoic chamber and the outcome used to compute the antenna phase centre, the precise point where the GPS measurements applies. Because the satellite body influences the antenna performance due to GPS signal reflections and multiple paths, numerous simulation runs were necessary. To crosscheck the simulations made at satellite level, a test with a partial assembly consisting of the SSTI antenna and a section of the GOCE solar wing mounted on an automatic robot was performed with live GPS signals outdoors. To further reduce path errors, (programmable) elevation cut-offs of 5° and 15° in the hemispherical coverage of the SSTI antenna are used for the best

GOCE Subsystems

1. Drag-Free and Attitude Control Subsystem (DFACS)

GOCE is the first ESA satellite employing 'drag-free control' and the first ever satellite to use electric propulsion to continually compensate for atmospheric drag.

Drag-free control means that the 'freefall' environment that space already provides is further enhanced by a factor of about 100 to exclude disturbances that otherwise would mask the gravitational forces on the test masses.

DFACS provides all on-board hardware and software functions to perform autonomous determination and control of the spacecraft attitude pointing, angular rates and linear and angular accelerations.

There are four DFAC modes for different stages of the mission or emergency and maintenance situations.

Coarse Pointing Mode (CPM)

Nominally entered after separation from the launcher. The satellite motions need to be damped and a safe attitude is acquired.

Extended Coarse Pointing Mode (ECPM)

The satellite attitude control is improved to minimise the cross-section exposed to the atmosphere and so limit altitude decay. This is necessary because in that stage the ion engine is not operating.

Fine Pointing Mode (FPM)

The satellite maintains its nominal attitude, waiting for the science measurement periods.

Drag Free Mode (DFM)

The satellite dynamics are controlled to a level that allows the science objectives to be fulfilled.

Attitude control is provided by the electric propulsion (ion) engine and 'magnetotorquers'. Magnetotorquers are tuneable electromagnets that use Earth's magnetic field as a stable frame against which to move the satellite. They exploit the same effect that aligns the needle of a compass to the north-south direction. The magnetotorquer would be the 'needle' and the strength of this 'needle' can be modulated to apply controlled torques to the spacecraft. Magnetotorquers can only provide instantaneous control in a plane orthogonal to the Earth magnetic field lines, thus only two axes can be controlled simultaneously. Advantages of a fully magnetic control are a low actuation noise due to fine command quantisation, high reliability and low mass.

2. Avionics and Radio Frequency Subsystem (RFS)

The Command & Data Management Unit (CDMU) consists of two sections: the on-board computer and the remote unit. The CDMU is fully internally redundant and makes use of fault tolerance features. The ERC32 32-bit RISC single chip processor (17 Mips/3.6 Mflops at 24 MHz) runs the Platform Application Software (PASW). This software is in charge of the data management, the thermal control, the drag-free attitude control and the overall fault detection, isolation and recovery.

Surveillance of the processor is performed by two Reconfiguration Modules (RMs). Main RM functions are the autonomous recovery function, the protected memory resources and the on-board time reference. Using an ultra-stable oscillator, the CDMU keeps the on-board elapsed time reference and maintains the on-board synchronisation across the GOCE platform with an accuracy of 200 nsec.

The CDMU communicates with other GOCE equipment either via a redundant Mil-Std-1553B bus and/or indirectly via the Remote Unit and its >500 discrete interfaces. Telemetry acquisition is supported by a 4 Gbit mass memory

Two S-band receivers are permanently active and are fed by the combined signal coming from both nadir- and zenith-pointing antennas located on the edge of each solar array wing. The resulting full spherical antenna ensures reception of telecommands even in case of attitude loss.

Operated in cold redundancy, the S-band transmitter is active during passes over ground stations only and transmits via the same nadir antenna as the one used for reception. Two TM modes are supported. TM-1, a low data rate mode of 63.7 kbps that allows tone ranging and the nominal mode TM-2 providing a 1.21 Mbps telemetry stream. Telecommands can be received at a bitstream of 4 kbps. Due to the low orbit ground station, contacts are very short. They typically last five minutes with a mean value of around 26 minutes per day. The satellite is able to autonomously operate for 72 hours without loss of science data.

3. The Ion Propulsion Assembly (IPA)

The electric propulsion system is the vital subsystem on GOCE. If it does not work for longer than eight days in a row, the mission runs the serious risk of being lost due to unrecoverable orbital decay. Apart from controlling and safeguarding the orbit, the other task of the engine is to ensure the drag-free attitude control in the flight direction.

At the engine's heart is an ion thruster, mounted on an adjustable alignment bracket to direct the thrust vector through the spacecraft centre of mass. For redundancy, two complete ion thruster assemblies are mounted externally on the last panel of the satellite. The spacecraft has a fuel tank with 40 kg xenon, sufficient for a 30-month mission.

The ion thruster is a 'Kaufman'-type electron bombardment ion motor and runs on xenon gas which is fed into a 10 cm diameter cylindrical discharge chamber both via a hollow cathode and a normal feed pipe.

The hollow cathode serves as an electron source to ignite and sustain the Xe plasma discharge inside the thruster chamber. An external magnetic field is applied to enhance the ionisation efficiency of the electrons and to guide the Xe ions towards the extraction grid system at the thruster exit.

Two carbon grids, well aligned and separated by about 1 mm, accomplish the acceleration of the Xe ions to 1170 eV and at the same time prevent unwanted backstreaming of ambient plasma electrons into the thruster. To prevent spacecraft charging, a second hollow cathode is used to emit an electron beam of equal magnitude but opposite sign to the ion beam.

The thruster can be throttled between 1 and 20 mN at rates compatible with the targeted mission profile and expected drag changes over individual orbits. Individual thrust steps as low as 12 μN can be commanded and slew rates between 1.7 mN/s to 2.5 mN/s depending on the thrust range are achievable. The measured thrust noise ranges between 1 and 10 $\mu\text{N}/\text{Hz}^{1/2}$.

Special care has been taken during the development and acceptance test campaign to assess thrust vector motion due to launch impact or ageing of the thruster. The thrust vector will be aligned to point exactly at GOCE's centre of mass prior to launch. Any deviation would otherwise introduce unwanted torques on the satellite.

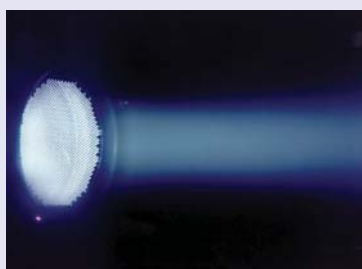

Left, ion thruster. Right, GOCE ion thruster operating at full thrust.

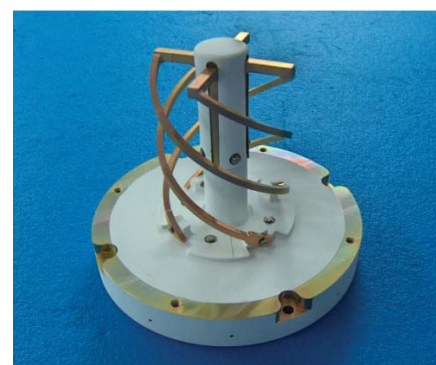

GOCE GPS antenna

quality GPS signal. On average, eight GPS satellites are visible.

Launch and Mission Analysis

GOCE will be the first ESA spacecraft having to face the danger of literally falling from the sky within weeks after a successful launch. GOCE mission analysis experts were given the challenge of a low flight, maintainable even without an ion engine for up to eight days. The task was delicate because of the lack of reliable atmospheric density data for altitudes between 250 km and 300 km. Furthermore, density variations by a factor of two are not unrealistic at short timescales, due to extreme solar conditions and on longer scales because of the 11-year solar cycle.

GOCE will be launched from the Plesetsk Cosmodrome in northern Russia with a Rockot vehicle. The Rockot is a modified SS-19 intercontinental ballistic missile that was decommissioned after the Strategic Arms Reduction Treaty. The launcher uses the two lower liquid fuel stages of the original SS-19 and is equipped with a third stage developed for precise orbit injection. Rockot is marketed by the German-Russian company Eurockot.

GOCE will be launched into a Sun-synchronous dawn-dusk orbit with an inclination of 96.70° and an ascending node at 6:00. Separation from the launcher will be at 295 km. The satellite's orbit will then decay over a period of 45 days to an operational altitude of 270 km. During this time, the spacecraft will be commissioned and the electrical

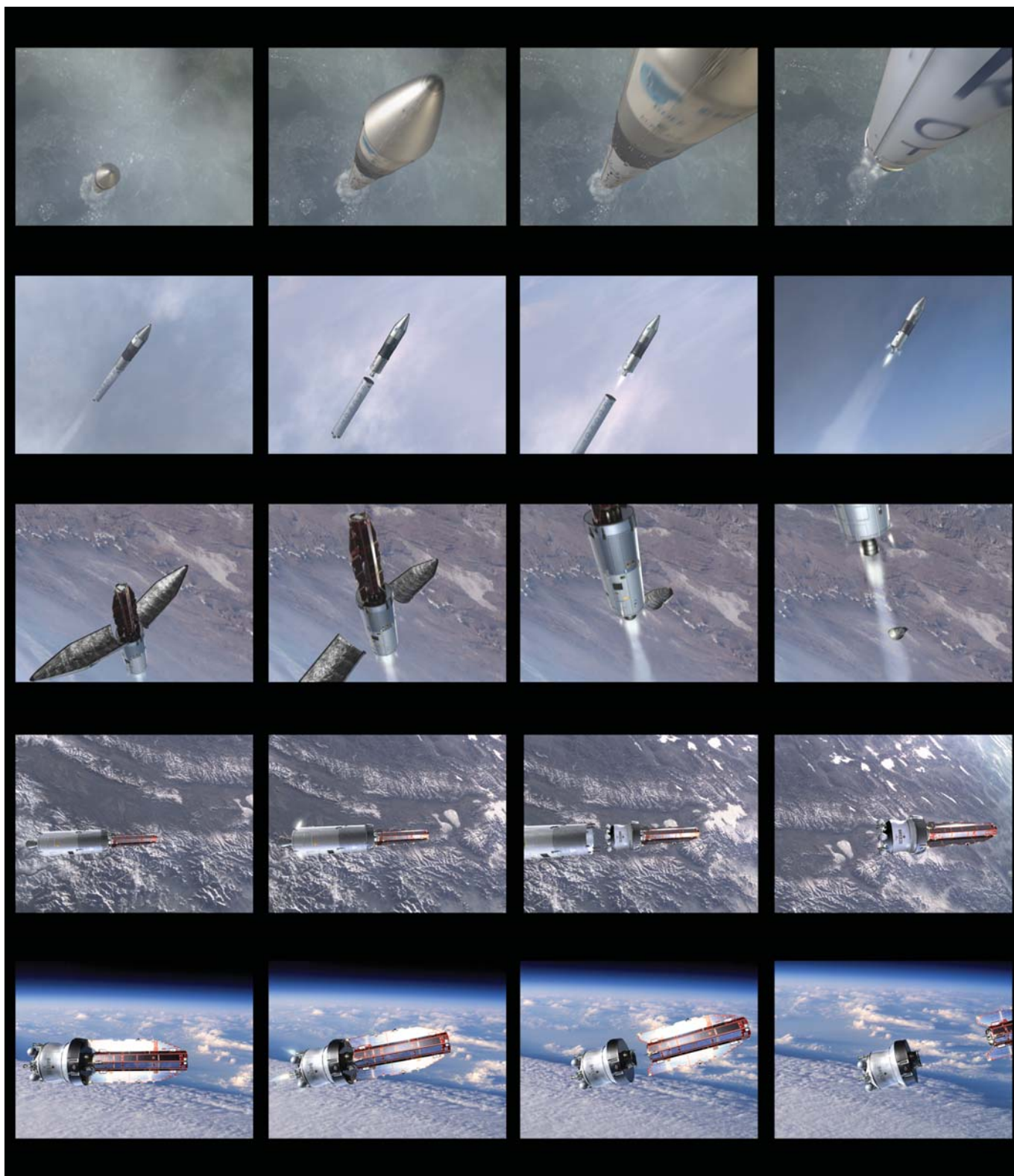

The GOCE launch sequence: the Rocket launcher, separation of the second stage, the fairing, and the separation of the GOCE spacecraft and the Rocket third stage (AOES Medialab)

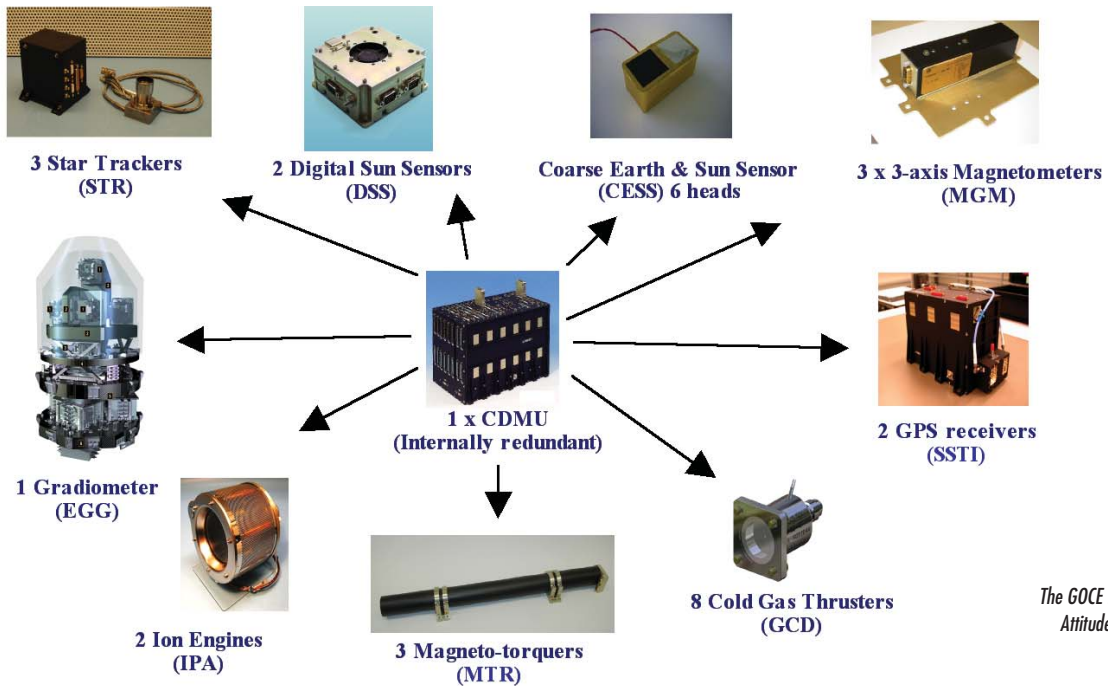

The GOCE Drag-free and Attitude Control Units

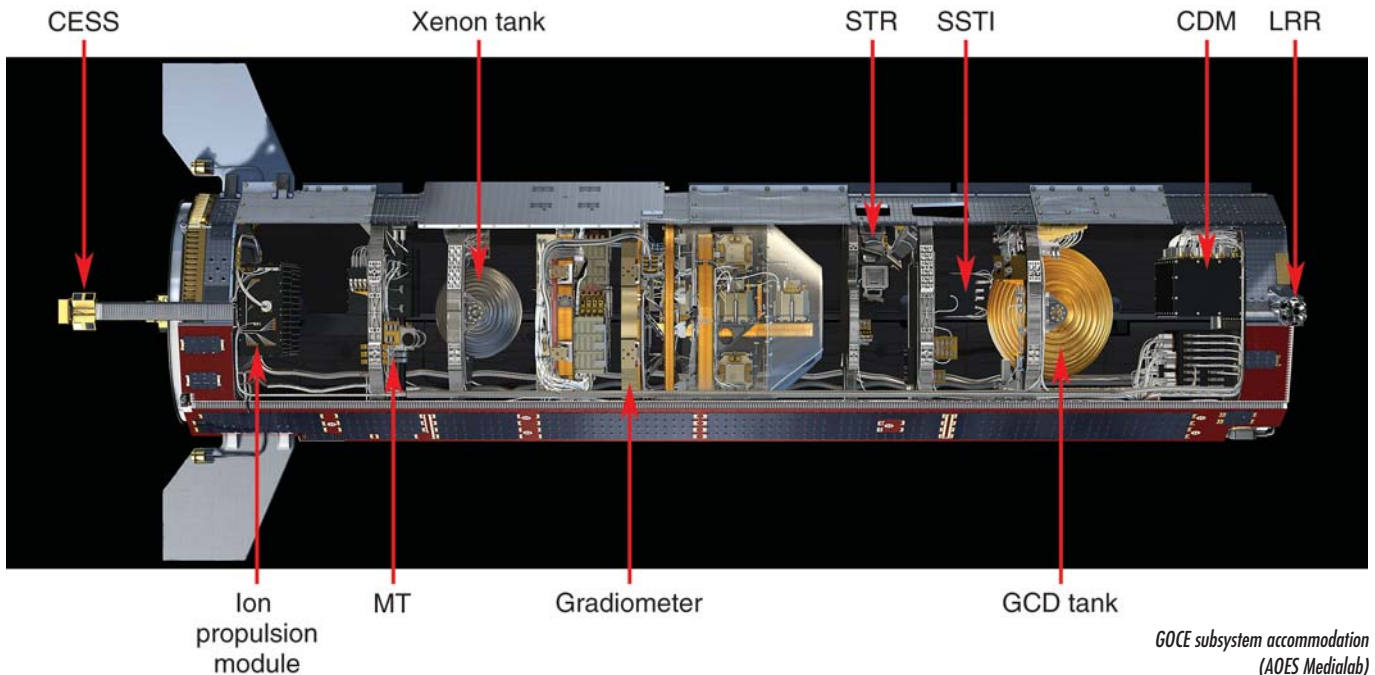

GOCE subsystem accommodation (AOES Medialab)

propulsion system will be checked for reliability in attitude control.

GOCE During Eclipse Season

The low orbit inevitably leads to two eclipse seasons per year. Short eclipses around 11 minutes per orbit occur during June and July; they do not affect the scientific measurements. The eclipse

seasons during October and February, however, lead to eclipse durations of typically 28 minutes and, due to power constraints, necessitate raising the orbit during that time. The actual power situation in orbit will determine whether the satellite needs to go into hibernation or if scientific measurements can be continued. The nominal GOCE mission

scenario includes two measurement phases interrupted by a hibernation phase. Due to the evolving solar cycle that leads to higher atmospheric densities, the second measurement phase needs to be carried out at a higher altitude. The exact value will be decided once in orbit when the actual spacecraft performance is known.



GOCE's Measurements of the Gravity Field and Beyond

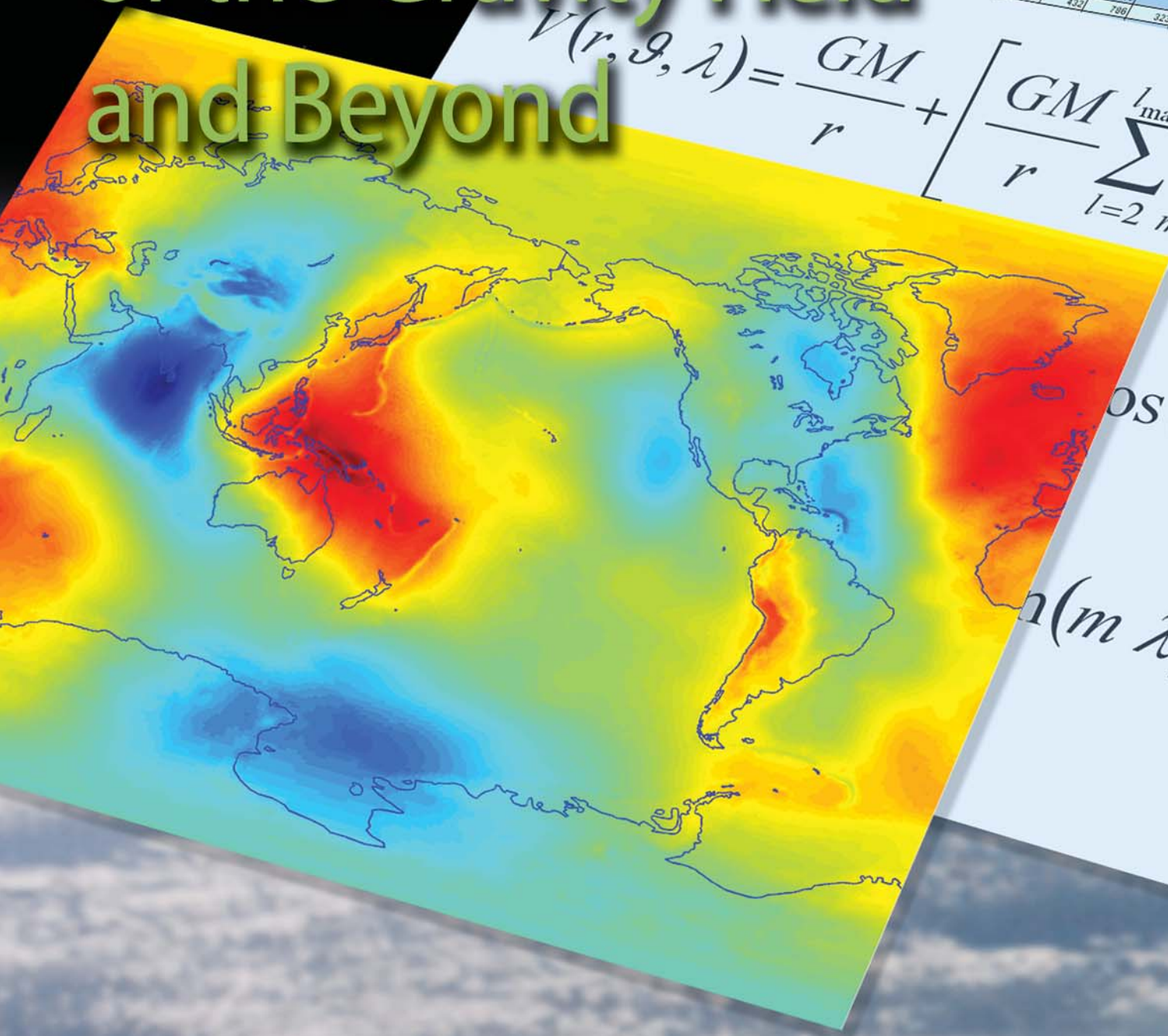

$$V(r, \vartheta, \lambda) = \frac{GM}{r} + \left[\frac{GM}{r} \sum_{l=2}^{l_{\max}} \sum_{m=0}^m \right]$$

| TIME Series | AG+AG2 | AG+AG2 | IS_SAME | Inst Type |
|-------------|--------|--------|---------|-----------|
| MOSE | 693 | 799 | 413 | 810 |
| GOCE | 410 | 769 | 383 | 841 |
| ESM | 694 | 383 | 408 | 631 |
| USMO | 419 | 769 | 383 | 841 |
| ESME | 347 | 101 | 310 | 421 |
| ALOE | 419 | 769 | 383 | 841 |
| ES | 375 | 774 | 403 | 816 |
| | 2 | 649 | 397 | 366 |
| | 320 | 143 | 432 | 786 |

$os(m$
 $n(m, \lambda))$

Rune Floberghagen

Ground Segment Department, Directorate of Earth Observation Programmes, ESRIN, Frascati, Italy

Mark Drinkwater, Roger Haagmans & Michael Kern

Science, Applications and Future Technologies Department, Directorate of Earth Observation Programmes, ESTEC, Noordwijk, The Netherlands

| Inst_Type | Inst_Conf | Inst_Name | Inst_Mission | Inst_Weight | Inst_Design | Inst_SWA | Inst_ACC | Mission1 | Mission2 | Mission3 | Mission4 | Mission5 |
|-----------|-----------|-----------|--------------|-------------|-------------|----------|----------|----------|----------|----------|----------|----------|
| 709 | 413 | 813 | 862 | 706 | 299 | 433 | 86322 | 706 | 299 | | | |
| 769 | 383 | 841 | 691 | 620 | 562 | 434 | | | | | | |
| 289 | 409 | 621 | 873 | 409 | 726 | 435435 | 2 | 820 | 562 | | | |
| 769 | 383 | 841 | 294 | 823 | 370 | 816 | 873 | 408 | 726 | | | |
| 181 | 310 | 841 | 733 | 787 | 307 | 653664 | 733 | 823 | 370 | | | |
| 19 | 383 | 841 | 648 | 397 | 366 | 2 | 648 | 13 | 307 | | | |
| 403 | 841 | 143 | 432 | 786 | 323 | 648 | 212 | 366 | | | | |
| 397 | 386 | 744 | 56 | 856 | 736 | 744 | 430 | 786 | | | | |
| 432 | 786 | 283 | 12 | 593 | 797 | 744 | 430 | 856 | | | | |
| | | | | 106 | 144 | 322 | 431 | 593 | | | | |
| | | | | | | | 832 | 106 | | | | |
| | | | | | | | | 306 | | | | |
| | | | | | | | | 638 | | | | |
| | | | | | | | | 350 | | | | |
| | | | | | | | | 871 | | | | |
| | | | | | | | | 351 | | | | |
| | | | | | | | | 309 | | | | |
| | | | | | | | | 313 | | | | |
| | | | | | | | | 564 | | | | |
| | | | | | | | | 97 | | | | |
| | | | | | | | | 183 | | | | |
| | | | | | | | | 808 | | | | |
| | | | | | | | | 436 | | | | |
| | | | | | | | | 759 | | | | |
| | | | | | | | | 299 | | | | |
| | | | | | | | | 562 | | | | |
| | | | | | | | | 726 | | | | |
| | | | | | | | | 370 | | | | |
| | | | | | | | | 307 | | | | |
| | | | | | | | | 366 | | | | |
| | | | | | | | | 786 | | | | |
| | | | | | | | | 856 | | | | |
| | | | | | | | | 583 | | | | |
| | | | | | | | | 105 | | | | |
| | | | | | | | | 306 | | | | |
| | | | | | | | | 638 | | | | |
| | | | | | | | | 350 | | | | |
| | | | | | | | | 871 | | | | |
| | | | | | | | | 307 | | | | |
| | | | | | | | | 366 | | | | |
| | | | | | | | | 786 | | | | |
| | | | | | | | | 856 | | | | |
| | | | | | | | | 583 | | | | |

Ocean circulation, sea-level rise and the ocean's role as a regulator of climate are just some of the critical phenomena that can be further studied with the help of GOCE's gravity field products. But how do the spacecraft's measurements become part of this new information source?

Introduction

GOCE will provide users worldwide with well-defined data products, and will be instrumental in advancing science and applications in many disciplines, ranging from geodesy, geophysics and surveying, to oceanography and glaciology. These data products are the starting point for deeper analysis in all related geosciences. All products are available free of charge to scientific and non-commercial users.

But just how will it all work? What are the physical measurements made by the satellite, and how can they be used to provide detailed information about the gravity field over the required range of spatial dimensions from global down to 100 km or less?



GOCE mission ground segment elements and inter-relations

Ground Segment

The ground segment is a key segment of the mission for the generation and quality control of the GOCE mission data products. Overall, the concept and architecture of the ground segment is based on data-driven processing for all steps wherever possible. Human interaction in the scientific data processing flow occurs only in the determination of the ultra-precise science orbits and of the gravity field solution.

Data-driven processing was selected for two reasons: first, little or no operator intervention is required as long as the data processing proceeds nominally; and second, it allows scientists and engineers to focus on critical areas such as instrument calibration, monitoring of the data quality, study of correction parameters, tuning of processing algorithms and parameters, and so on.

The interface to the satellite, including all satellite operations, command and control, is taken care of by the Flight Operations Segment at ESOC,

Darmstadt. Regarding the science data product generation, the key components of the ground segment are the Payload Data Ground Segment (PDGS), the High-level Processing Facility (HPF), and the Calibration Monitoring Facility (CMF). The HPF is a distributed processing chain developed and operated under ESA contract by a consortium of ten European institutes, known as the European GOCE Gravity Consortium (or EGG-C).

The definitions for the different levels of GOCE data products are:

Level 0 time-ordered raw data as measured by GOCE. The satellite downlinks the data during contact with a dedicated ground-receiving station.

Level 1b time series of calibrated and corrected instrument data along the orbit. These data include the primary instrument data: gravity gradients, satellite-to-satellite tracking observations and GOCE satellite position; ancillary data such as the satellite linear and angular accelerations and satellite attitude.

Level 2 time series or models of key GOCE science products based Level 1b data; primary gravity field models and ultra-precise science orbits.

Level 2 data products are regarded as the starting point for further scientific analysis, and will be GOCE-only gravity-field solutions. Such application products – sometimes referred to as Level 3 products – are thus value-added, derivative or custom products developed for application in further studies of solid-earth physics, absolute ocean circulation, geodesy, sea-level rise, etc. Additionally, products requiring combinations of surface or airborne gravimetric data, or other satellite or in situ data with the GOCE data are regarded as Level 3 data products.

Within the PDGS, the Payload Data Segment (PDS), which includes the Instrument Processing Facility (IPF) running all the processing computer code, produces the Level 0 and Level 1b data products and provides them, together with auxiliary parameter files, to the HPF. The HPF in return pre-processes the Level 1b data, generates Quick-Look (QL) analysis products (these are rapid products used mainly to assess and verify the Level 1b data quality), and returns Level 2 products to the PDS for archiving and distribution to users.

Additionally, the PDGS hosts the Long-Term Archive (LTA) for data preservation and archiving purposes, the Multi-mission User Services facilities (MUS) through which the users can obtain access to the data, and the Performance Monitoring Facility (PMF) which monitors the overall mission data production and data flow.

Meanwhile, the CMF is responsible for the continuous monitoring of the Level 1b product performance as well as the satellite performance on the basis of data collected in the PDS. It also relates the product performance to the satellite health, configuration and instrument performance, and is therefore also a satellite performance monitor. Based on the CMF findings, planning files and auxiliary files needed for satellite flight

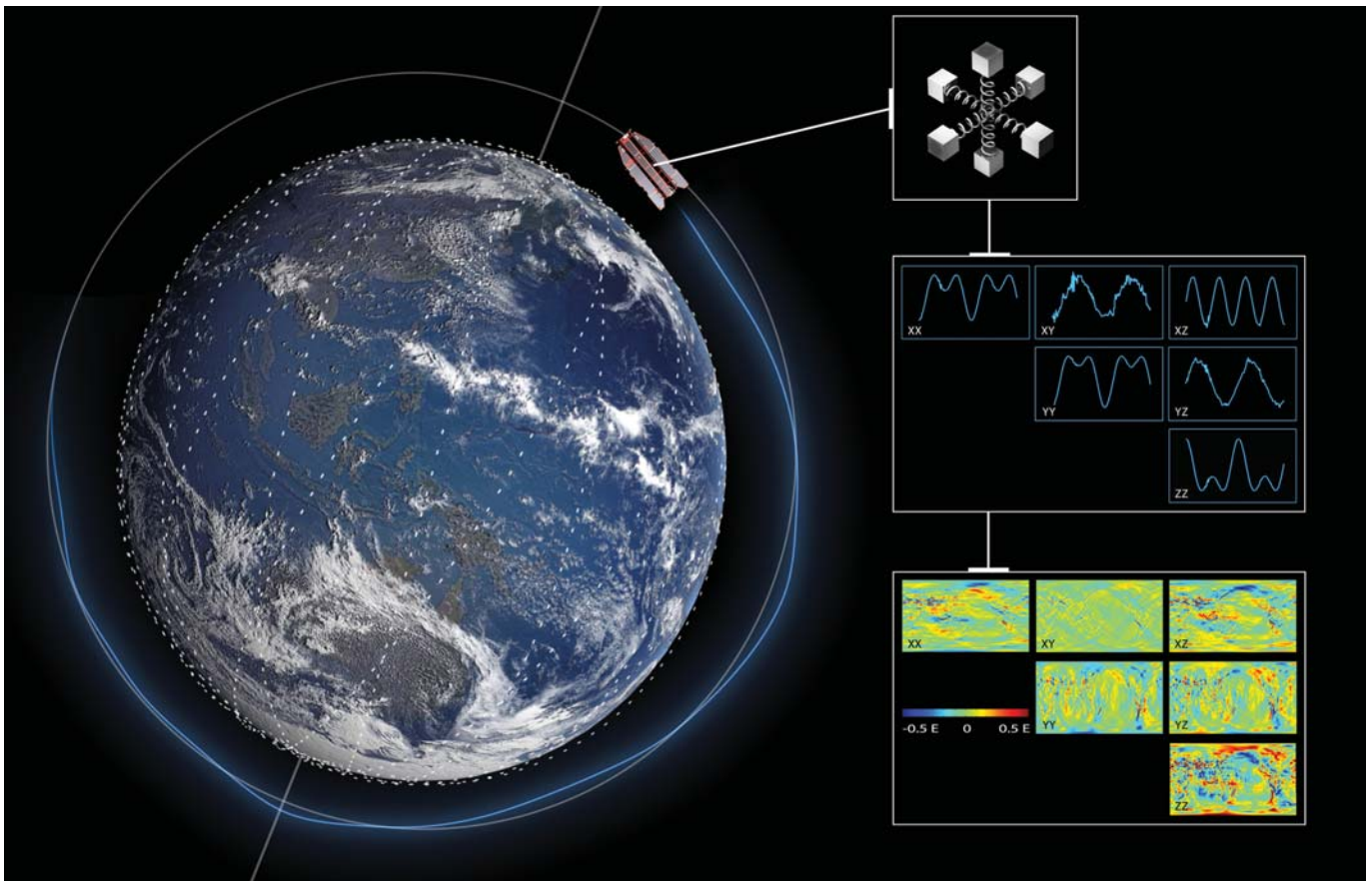

Collection of time series of gravity gradients (upper right). GOCE will collect such measurements all over the world (lower right) (AOES Medialab)

control, payload calibration operations and/or data processing are generated by the Reference Planning Facility (RPF).

The HPF plays an instrumental role in the overall scientific calibration and validation of the Level 1b data products, as it generates Level 2 quick-look and final products, and also performs dedicated quality assurance functions on the incoming Level 1b data products.

The GOCE mission uses ground stations in Kiruna and on Svalbard to exchange commands with the spacecraft and to downlink data to the ground. During operations, the satellite is monitored and controlled by ESOC, Darmstadt. ESOC generates and uplinks commands to programme the GOCE satellite operations, and processes the housekeeping and instrument data to monitor the health status and performance of the platform and the instruments.

While PDS generates Level 1b data

products, the HPF generates the Level 2 products. It is expected that most science, service and application users will eventually be mostly interested in the Level 2 data. Once validated, both types of products are available through the standard ESA user services tools. A common feature of all product levels is that the products contain all corrections and outcome of each individual processing step. The process is therefore essentially reversible, should it be desirable to apply different corrections/steps at a later stage, e.g. based on new insight or new (geophysical) background data and/or models.

GOCE implements the multi-mission concept that is now common to all the missions of the Earth Explorer family. The ground segment and the users must deal with a generalised data representation common to all Earth Explorer missions, and the products follow specific format guide-lines. GOCE

products are all ASCII, and the main products are coded in eXtensible Markup Language (XML). In XML, each and every data set is characterised by specific tags that prevents format errors and allows immediate validation against existing specific format descriptions like XML standard descriptors. As XML-based product formats are not yet common-place in the geosciences community, ESA intends to provide access to tools that can be used to read and convert mission products into several current product formats, such as RINEX (for GPS data) and others.

The two instrument techniques used to achieve the mission goals are gradiometry and high-to-low satellite-to-satellite tracking (SST-hl), and the primary payload of the mission consists of the EGG and the SSTI. In gradiometry, the difference in the acceleration measured by two accelerometers placed some fixed distance apart provides the basic

observable, proportional to the gravity gradient in the direction joining the two sensors through a constant scale factor. In SST-hl, the positional data measured with respect to a constellation of reference satellites in known orbits are used to extract the gravity information through orbit perturbation analysis. In these techniques, knowledge of the orbit allows for the retrieval of the underlying dynamic models that govern the satellite motion, including the Earth gravity field. The two techniques are complementary in that SST-hl works best at providing the long and medium-wavelength part of the geopotential, while gradiometry is especially sensitive to the short-wavelength part. The crossover frequency between the two techniques is not sharply defined, providing redundant measurements in a relatively wide frequency band.

The measurement bandwidth of the EGG is defined to cover the frequency range between 5 mHz and 100 mHz, the upper limit being consistent with the required spatial resolution of 100 km.

Gradiometer Data Processing – First Steps

Getting meaningful gravity gradient information from the science data telemetry received by the ground station(s) starts – as part of the Level 1b processing – from a Level 0 product that contains all gradiometer nominal science mode instrument source packets as extracted from the raw satellite telemetry. These hexadecimal data packets are unpacked, sorted and converted into engineering units.

Data gap information on the time series of data is stored in the product for future reference and use. It is important to note that all GOCE measurements are time-tagged according to GPS system time as well as according to the on-board elapse time counter. The precision of the GPS system time stamping is higher than the one generally ensured by commonplace on-board time to UTC clock conversions since the relationship between the on-board clock and the GPS time is derived from the navigation orbit and clock

solution provided by the GPS receiver. Gradiometer and SSTI instrument clocks are therefore aligned with a precision at the level of nanoseconds.

The fundamental observable from the gradiometer are the accelerometer control voltages; these are the voltages that are applied to the electrodes in order to keep the proof-mass levitated at the centre of the glass cage. In total, there are eight electrode pairs for each of the six accelerometers that make up the gradiometer instrument. Control voltages are corrected for gain and phase delay induced by both the accelerometer closed-loop control as well as the read-out circuitry by means of a discrete time filter. The (48) thus-corrected voltages are recombined to obtain the (36) accelerations – for every accelerometer (6) and

every degree of freedom (6). Common-mode and differential-mode accelerations of the three single-arm (one-directional) gradiometers are finally formed by taking the sum and difference of accelerations measured by each pair in three orthogonal directions. While the common-mode cancels out the gravity gradient signal we are trying to measure, this signal does contain the non-conservative (or surface) forces acting on the satellite, preventing the satellite from being in gravitational free-fall. Therefore, this signal is ideally suited as input for the satellite drag-free control.

The drag-free control system nullifies this common-mode signal along the satellite orbit by proper continuous actuation of the ion propulsion system. The differential-mode signal on the

Final gravity gradient product after preprocessing and geophysical calibration

| Corrected and calibrated gravity gradients | |
|--|--|
| GPS Time | Gradient observation time (sec) |
| Gravity gradients | Externally calibrated & corrected gravity gradients V_{xx} , V_{yy} , V_{zz} , V_{xy} , V_{xz} , V_{yz} in $[1/s^2]$ |
| Errors of gravity gradients | Sigmas of all 6 gravity gradients derived from a-priori or HPF estimated gradiometer error model in $[1/s^2]$ |
| Gradient flags | Flags for each gravity gradient as 1 byte integer. Meaning of numbers: 0: Original gradient (from Level 1b product) 1: Original gradient, temporal corrections added 2: Original gradient with temporal and ext. calibration added 3: Outlier suspected, fill-in provided (from spline interpolation) 4: Outlier suspected, no fill-in, as for 2 5: Data gap, fill-in provided (from spline interpolation) 6: Data gap, no fill-in provided. |
| Direct tides | Correction applied for direct tides for all 6 gradients in $[1/s^2]$ |
| Solid Earth tides | Correction applied for solid Earth tides for all 6 gradients in $[1/s^2]$ |
| Ocean tides | Correction applied for ocean tides for all 6 gradients in $[1/s^2]$ |
| Pole tides | Correction applied for pole tides for all 6 gradients in $[1/s^2]$ |
| Non-tidal mass variations | Correction applied for combined atmospheric & oceanic mass variations for all 6 gradients in $[1/s^2]$ |
| External calibration | Correction applied due to external calibration for all 6 gradients in $[1/s^2]$ |

other hand does not contain the surface forces acting on the spacecraft (as they are essentially the same for paired accelerometers). The signal is instead proportional – by the distance between the two accelerometers of a pair – to the derivative of accelerations, in other words the gravity gradient. However, because the satellite is rotating along its orbit, the thus-obtained gravity gradient must be corrected for angular and centrifugal accelerations before we have retrieved a clean gravity gradient measurement in the instrument reference frame. As part of the quality assessment activities the trace of the gravity gradient tensor (i.e. the sum of the three orthogonal gradients) is computed for each measurement epoch (each second), and from this time series

the spectral behaviour of the retrieved gravity gradient can also be studied.

Gradiometer angular accelerations are derived from combination of the differential mode accelerations of the one-axis gradiometers. Derivation of the angular rates, needed to compute the centrifugal acceleration term is a rather elaborate procedure that is accomplished in two phases: inside the gradiometer measurement bandwidth (5–100 mHz) the angular rate reconstruction is obtained by integrating the gradiometer angular accelerations. Below a few mHz, however, the gradiometer measurement errors become too large: the angular rate information is instead obtained by differentiation of the star tracker attitude measurements. The combi-

nation of the two sources of data is done through a modified Kalman filter.

It is worth mentioning that in case a single accelerometer fails, the failing accelerometer can be ‘replaced’ – at the cost of a certain performance degradation – by a so-called ‘virtual accelerometer’ that is obtained by recombination of the acceleration measurements provided by the remaining five accelerometers.

Satellite-to-Satellite Tracking Data Processing – First Steps

In analogy to the case of the gradiometer, the processing of the SSTI/GPS receiver data starts from a Level 0 product that contains all SSTI nominal instrument source packets extracted from the satellite telemetry. The packets are unpacked, sorted and converted into engineering units. The local on-board time and the GPS time of the receiver unit are stored within the time correlation data. Measured carrier phases are corrected for an inter-frequency bias, which results from a different treatment in the analogue receiver electronics of the GPS signal on the two different L-band frequencies. This bias depends largely on the temperature trends and on the receiver characteristics. Invalid data (e.g. due to cycle slips and outliers/offsets) are also identified and flagged.

Pseudo-range measurements (of the distance between GOCE and the transmitting GPS satellites) are corrected for inter-channel bias, i.e. a small bias between the various 12 channels of the receiver. This bias is characterised on the ground and may also be re-evaluated during the mission by sending the signal from the same GPS satellite through all receiver channels. On a parallel track, and in order to assess the noise level of the data, the GPS code measurements are subject to a smoothing process using a suitable order polynomial. Standard deviations of the fit of the measurements to the smoothing polynomial are computed and stored for quality monitoring purposes: they represent a

Gravity gradients in an Earth-fixed reference frame. Corrected for temporal gravity field variations, outliers, data gaps and externally calibrated

| Gravity gradients in Local North-Oriented Reference Frame (LNOF) | |
|---|--|
| GPS time | Gradient observation time in [sec] |
| Position | Geocentric latitude in [deg], longitude in [deg], height in [m] |
| Gravity gradients | Externally calibrated & corrected gravity gradients V_{xx} , V_{yy} , V_{zz} , V_{xy} , V_{xz} , V_{yz} in [$1/s^2$] |
| Errors of gravity gradients | Sigmas of all 6 gravity gradients derived from a-priori or HPF estimated gradiometer error model in [$1/s^2$] |
| Gradient flags | Flags for each gravity gradient as 1 byte integer |

The precise orbit data product. Variance-covariance information is included for the kinematic orbits (over 9 epochs) and the rotation matrix for each epoch from the Earth-fixed to the inertial reference frame in terms of quaternions

| Precise science orbits from reduced dynamic approach (positions and velocities) and kinematic approach (positions), both in Earth-fixed frame | |
|--|---|
| Kinematic orbit | GPS time in [sec] X, Y, Z position in [m] in Earth fixed frame Clock correction Standard deviation of position and clock Variance-covariance matrix for positions (over 9 epochs) |
| Reduced dynamic orbit | GPS time in [sec] X, Y, Z position in [m] in Earth fixed frame X, Y, Z velocity in [m/sec] in Earth fixed frame Standard deviation of position and clock |
| Rotation matrix from EFRF to IRF | GPS time in [sec] Quaternions (4) describing rotation angles |

| GOCE gravity field model in different representations including geoid error | |
|---|---|
| Spherical Harmonic Series (SHS) | Degree; order; C/S-coefficients; sigmas of coefficients (dimensionless) |
| Geoid heights | 30'x30' global grid with geoid heights [m] using wgs84 as reference ellipsoid. |
| Gravity anomalies | 30'x30' global grid with gravity anomalies in [m/s ²] using wgs84 as reference ellipsoid. |
| North-south deflection of the vertical | 30'x30' global grid with north-south deflections of the vertical [arcsec] using wgs84 as reference ellipsoid. |
| East-west deflection of the vertical | 30'x30' global grid with east-west deflections of the vertical [arcsec] using wgs84 as reference ellipsoid. |
| Geoid height error | 30'x30' global grid with geoid height standard deviation computed from error propagation of full variance-covariance matrix[m]. |

Final gravity GOCE gravity field product

first-hand estimate of the ‘noise level’ of the range measurements.

An orbit solution is also computed from the filtered pseudo-ranges; this orbit solution is accurate to about 10 metres. To this end, GPS satellite constellation position and clock data are obtained from the International GNSS Service (IGS). Such IGS data are interpolated to SSTI measurement epochs and corrected for GPS satellite antenna phase centre offsets as well as for relativistic effects. A certain robustness is also built in the processing scheme in order to account for a possibly unavailability of one frequency of data from the SSTI, for example in cases of low signal-to-noise ratios. In principle, both a navigation Kalman-filtered solution as well as single-point positioning orbit solution can be computed. The statistics of the computation are stored as a quality indicator for the computed solution. Finally, the position solution is translated from the antenna phase centre to the satellite centre-of-mass.

Level 2 Data Products – The Next Step

GOCE Level 2 products include gravity gradients, precise orbit solutions, as well

as gravity field models. All Level 2 data products are generated by the HPF.

Gravity Gradient Products

For processing of the nominal gravity gradients from Level 1b to the Level 2, several processing steps are applied:

- correction of gravity gradients due to external calibration based on readily available gravity field information (our current knowledge of the gravity field);
- determination of gravity gradient errors (uncertainties) from an error model;
- detection of outliers and computation of fill-in values, if possible;
- identification of data gaps and computation of fill-in values, if possible;
- computation of gravity gradient corrections for tides; this includes direct tides, solid Earth tides, ocean tides and pole tides; and
- computation of gravity gradient corrections for atmospheric and oceanic mass variations.

This ensures that the originally observed gravity gradients are reproducible from the Level 2 gravity gradient products.

Transformed Gravity Gradients

For various applications gravity gradients are needed in an Earth-Fixed Reference Frame (Local North-Oriented Reference Frame). The six gravity gradients contained in this product are computed from the four accurately observed gradients which are first high-pass filtered to avoid the large long-wavelength errors present in the GRF gradients to map into the LNOF gradients (the long-wavelength part is replaced by a reference gravity model). The less well-observed gradients V_{xy} and V_{yz} are not used in order to avoid their large error to couple into the transformed gradients.

Because of the dependency on the a-priori gravity field model this product is not useful for gravity field determination, but well suited for many geophysical/oceanographic applications requiring localised gravity gradients in an Earth-fixed frame.

Precise Science Orbits

Precise science orbits are computed from the GPS space receiver phase and pseudo-range observations (SSTI instrument). Two techniques are applied: (1) Reduced dynamic orbits are computed based on a set of a-priori (dynamic) models needed for estimating all forces acting on the satellite. (2) Applying a purely geometric approach for the satellite positioning, ‘kinematic’ orbits are determined. These are completely independent from any a-priori knowledge of the force models. Both solutions have advantages and disadvantages. While reduced dynamic orbits are somehow smoothed, due to the dynamical modelling, kinematic orbits contain the pure geometrical solution of the positioning problem. Kinematic orbits may therefore be noisier, but may also contain higher frequency orbit information.

Gravity Field Products

From gravity gradiometer data and orbit solutions the final GOCE gravity field models are computed. It is planned to provide (at least) one gravity field model

for each measurement operations phase of six months duration, as well as one final model based on all measurement operation phases. Within the HPF, there are three parallel methods implanted for the gravity field determination, providing important redundancy and cross-validation possibilities that will ultimately guarantee the quality of the GOCE gravity field product. These three methods combine traditional methods with novel methodologies developed specifically for the GOCE mission.

A gravity field model consists of several measurement data sets. These are the coefficients of a spherical harmonic series as the initial result of the gravity field estimation procedure and derived quantities like geoid heights, gravity anomalies and deflections of the vertical. Based on the variance-covariance matrix, a complete error propagation is

performed to compute the geoid height errors on a regular grid. This grid also is part of the GOCE gravity field solution.

The derived quantities are computed under the assumption of spherical approximations in order to avoid the need of a digital terrain model, which is not part of the GOCE processing system. For applications requiring derived quantities, for example in high-mountain areas, the spherical approximation might be not accurate enough. In this case the accurate formulas involving a digital terrain model have to be applied.

As second product the complete variance-covariance matrix of the spherical harmonic series coefficients is available.

Access to the Data

ESA strives for the widest-possible use of its Earth observation data in research

and application areas. All mission data products described here are available free of charge to scientific and other non-commercial users worldwide. In order to establish a first mission data user community, a dedicated Announcement of Opportunity was released in 2006. After a peer-review process this led to the selection of a first set of user projects, approximately 70 in total spread over nearly 140 research groups, institutes and universities.

A second call for registration of user projects is expected about six to nine months after launch in conjunction with the release of the first data. Nonetheless, user registration can be done at any time, irrespective of the dedicated calls from the ESA, through the Earth Observation Principal investigator web portal:

<http://leopi.esa.int/goce>.



James Webb Space Telescope

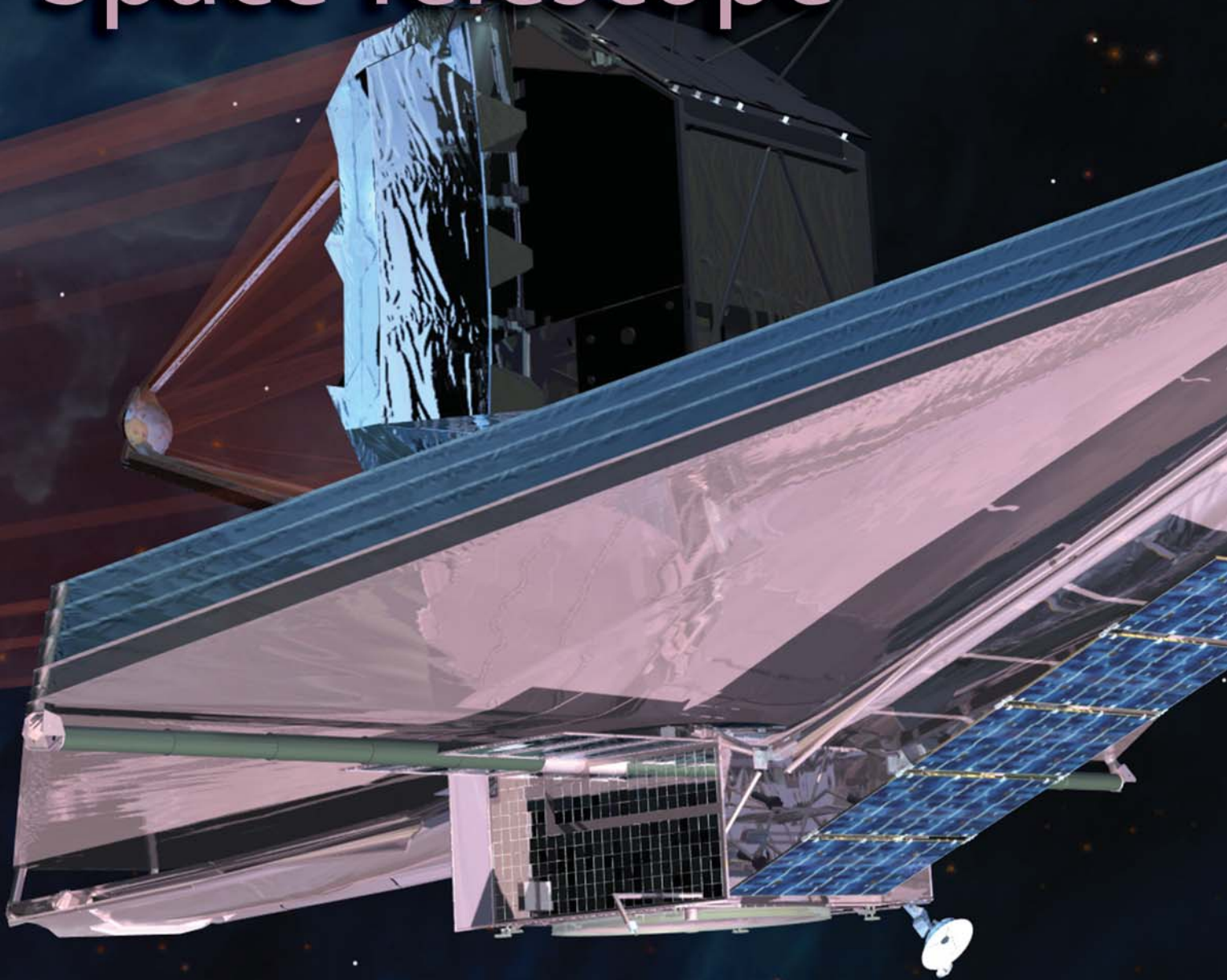

A Bigger and Better Time Machine

Peter Jakobsen & Peter Jensen
Directorate of Scientific Programmes, ESTEC,
Noordwijk, The Netherlands

Inspired by the success of the Hubble Space Telescope, NASA, ESA and the Canadian Space Agency have collaborated since 1996 on the design and construction of a scientifically worthy successor. Due to be launched from Kourou in 2013 on an Ariane-5 rocket, the James Webb Space Telescope is expected to have as profound and far-reaching an impact on astrophysics as did its famous predecessor.

Introduction

Astronomers cannot conduct experiments on the Universe, instead they must patiently observe the night sky as they find it, teasing out its secrets only by collecting and analysing the light received from celestial bodies. Since the time of Galileo, the foremost tool of astronomy has been the telescope, feeding first the human eye, and later increasingly sensitive and sophisticated instruments designed to record and dissect the captured light.

With the coming of the Space Age, astronomers soon began sending their telescopes and instrumentation into orbit, to operate above the constraining window of Earth's atmosphere. One of the most successful astronomical



James E. Webb escorts President John F. Kennedy during a visit to a NASA centre in 1963

Who was James Webb?

James E. Webb (1906-92) was NASA's second administrator. Appointed by President John F. Kennedy in 1961, Webb organised the fledgling space agency and oversaw the development of the Apollo programme until his retirement a few months before Apollo 11 successfully landed on the Moon. Although an educator and lawyer by training, with a long career in public service and industry, Webb can rightfully be considered the father of modern space science. During his tenure as administrator, Webb insisted that NASA not only focused on manned spaceflight, but also embarked on a balanced programme of scientific research. As a result, by the time of his retirement, NASA had already launched some 75 scientific missions in astronomy, planetary exploration and space science.



observatories launched into space to date has been the NASA/ESA Hubble Space Telescope (HST), which operates at visible wavelengths, with excursions to the ultraviolet and near-infrared.

Although HST's 2.4 m-diameter collecting mirror is dwarfed by many far larger modern telescopes on the ground, from its vantage point above the blurring turbulence of the upper atmosphere HST has provided the deepest and clearest views yet of nearly all types of astronomical object. Some of the more spectacular HST images have even achieved iconic status with the general public.

Launched in April 1990, HST has since been repaired, maintained and its instruments upgraded during four subsequent visits by the Space Shuttle. HST is presently scheduled to undergo its fifth and final servicing mission in August 2008.

Since 1996, NASA, ESA and the Canadian Space Agency (CSA) have cooperated on designing and constructing a worthy successor to the Hubble Space Telescope. Known initially as the Next Generation Space Telescope, the project was renamed in 2002 as the James Webb Space Telescope (JWST) after the former NASA administrator led the US agency during one of the most impressive projects in history – landing a man on the Moon.

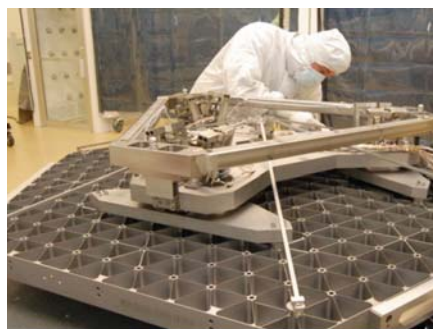
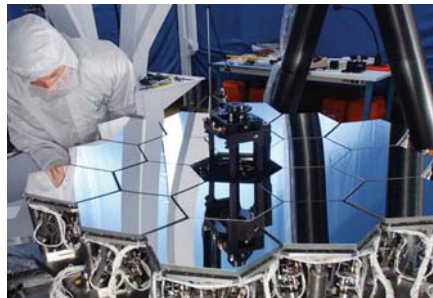

Telescope elements: (top to bottom) scaled-down testbed; prototype mirror backplane segment; and mirror segment attachment and adjustment mechanism

Although in several aspects JWST represents a radical departure from its predecessor, the astronomical capabilities of the JWST telescope and its instruments are very much driven by the scientific successes of HST, especially concerning exploration of the early Universe.

The Observatory

The JWST observatory consists of a 6.55 m-diameter telescope, optimised for diffraction-limited performance in the near-infrared (1–5 μm) and mid-infrared (5–28 μm) wavelength regions. The reason for the large telescope aperture and shift to the infrared is the desire to follow the contents of the faint extragalactic Universe back in time, to the epoch of 'First Light' and the ignition of the very first stars.

Nonetheless, like its predecessor, JWST will be a general-purpose observatory and carry a full suite of astronomical instruments capable of addressing a broad range of outstanding problems in current astrophysics. In contrast to HST, however, JWST will be placed into an orbit, known as an 'L2' halo orbit, some 1.5 million km from Earth and away from the Sun in deep space. This means that it is not designed to be serviceable after launch.

JWST will carry a total of four scientific instruments whose capabilities



Artist impression of the deployed JWST in orbit showing the 6.55 m segmented telescope mirror and matching sunshade (Northrop-Grumman)

together span the full contents of an astronomer's toolbox:

- NIRCam: a wide field (2.2 x 4.4 arcmin) near-infrared camera covering the wavelengths 0.6-5 μm
- NIRSpec: a wide field (3.5 x 3.5

arcmin) multi-object near-infrared spectrometer covering the wavelengths 0.6-5 μm at spectral resolutions of R~100, R~1000 and R~2700

- MIRI: a combined mid-infrared camera (1.4 x 1.9 arcmin) and spectrograph (R~100 and R~2000) covering the wavelengths 5-27 μm
- FGS/TFI: a fine guidance camera that also carries a near-infrared tunable filter imaging capability (2.3 x 2.3 arcmin; R~100).

telluride (HgCdTe) detector arrays employed by the three near-infrared instruments. Cooling is achieved by keeping the telescope and its instrumentation in perpetual shadow behind a large deployable sunshade. Further cooling of the MIRI instrument to below -263°C is achieved with a dedicated mechanical cooler.

The telescope is made up of 18 hexagonal segments, and is specified to yield diffraction-limited performance at wavelengths above 2 μm in the near-infrared. In order to fit into the shroud of the ESA Ariane-5 launcher, the 6.55 m primary mirror needs to be folded and deployed with the secondary mirror once in orbit. The precise positioning of each telescope segment is individually

The telescope and its instruments are to be cooled in bulk down to -240°C , a temperature determined to avoid telescope self-emission in the near-infrared and the required operating temperature of the mercury-cadmium-

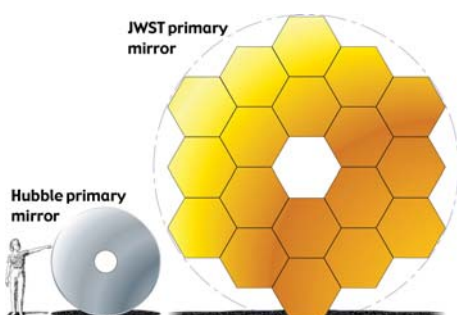

Comparison of Hubble and JWST mirrors (NASA)

Chasing the 'Redshift'

The story of modern astrophysics is one of ever-growing telescopes and ever-more sensitive instruments to look deeper into space. This obsession with the most distant objects has to do with the fact that the further away an object, the 'older' the light received, because of the finite speed of light. Astronomers can therefore 'look back in time' just by looking far enough away. They can observe directly the conditions in the Universe billions of years ago. With a big enough telescope, it is theoretically possible to map how stars and galaxies came into being and subsequently evolved nearly all the way back to the 'Big Bang', some 13.6 billion years ago.

An important consideration for exploration of the early Universe, however, is the accompanying 'redshift' effect. Because of the expansion of the Universe, the wavelength of light emitted by a remote galaxy becomes stretched during its long travel to Earth. The amount by which the received wavelength is stretched is determined by how much the Universe expanded in the time since the light was emitted.

The more distant the galaxy, the greater the redshift. The most remote galaxies known today have their light redshifted by a factor of nearly 8, meaning that we are viewing these objects when the Universe was only one eighth its present size. This is equivalent to looking back some 12.9 billion years into the past, or 95% of the way back to the Big Bang.

This 'redshifting' of light occurs at all wavelengths. To explore the 'normal' visible light emitted by the stars contained in more remote (i.e. younger) galaxies, astronomers have no choice but to chase this light deep into the infrared. This explains why JWST needs to both have a larger collecting mirror and be optimised for longer wavelengths compared to HST.

Redshift is also important because it allows astronomers to sort, by distance and age, the thousands of remote galaxies detected in very long camera exposures, such as those made in the Hubble Ultra Deep Field survey. Separating the light of a remote galaxy into its component colours, by passing it through a prism or reflecting it off a diffraction grating, allows the intensity of the light received to be measured at each wavelength. The detailed shape of the resulting 'spectrum' of the galaxy enables astronomers to infer not only the types, but also the ages and chemical composition of the stars that make up the galaxy. Equally important, the distance to the galaxy can be determined by measuring the redshift of the spectrum; that is, the amount by which the observed spectrum is shifted toward the red with respect to how it would look if the same galaxy were at rest. The task of measuring the redshifts of many faint galaxies simultaneously is one of the primary design drivers behind the ESA-supplied NIRSpec instrument on JWST.



The Hubble Ultra-Deep Field image is the farthest look into the Universe by astronomers to date. Some 10 000 faint galaxies are visible in this million-second exposure, the most remote of which emitted their light when the Universe was only 5% of its present age. Exploring these galaxies spectroscopically and probing even further back in time is a key scientific goal of the JWST mission (NASA/ESA/STScI)

JWST will be operated in a manner similar to the HST. The Space Telescope Science Institute (STScI), which operates HST, is under contract to NASA to serve as the operations centre for JWST and will take on responsibility for the scientific exploitation of the observatory and its instruments after successful commissioning.

At the time of writing, the JWST project is approaching completion of the final critical design phase and remains on schedule for a launch in 2013.

The NIRSpec Instrument

The ESA NIRSpec instrument on JWST is in many ways complementary to the NASA-funded JWST NIRCам near-infrared camera. While NIRCам takes direct pictures of a patch of sky through the JWST telescope, NIRSpec is designed to measure the spectra of pre-selected objects contained in it. This reflects the nature of celestial exploration: new interesting astronomical objects are often first discovered through imaging, but uncovering their astrophysical properties invariably requires detailed follow-up spectroscopy.

NIRSpec is a multi-object spectrograph, meaning that it is capable of measuring the spectra of up to 100 objects simultaneously. NIRSpec will be the first such astronomical spectrograph to fly in space. NIRSpec achieves this feat thanks to its novel micro-mechanical slit selection device. In the first stage of the NIRSpec optical chain, the field of view to be studied is imaged onto a Micro-Shutter Array (MSA) consisting of just under a quarter of a million individually addressable micro-shutters. The light from the objects under investigation is then isolated and allowed to enter the instrument by programming the MSA to only open those shutters coinciding with the pre-selected objects of interest. The remainder of the optical chain then serves to separate the light passing through the shutters into its component colours by means of a prism or a diffraction grating. The resulting

controllable in six degrees of freedom, and the radius of curvature of each segment can also be adjusted if needed. Telescope fine alignment will be achieved on orbit with the help of various pupil-imaging diagnostic modes included in the NIRCам instrument.

Fine pointing of the telescope will be achieved by deflecting the beam by means of a fast steering mirror controlled by the Fine Guidance Sensor (provided by the Canadian Space Agency) located in the telescope focal plane.



The qualification model of the NIRSpec front optical system undergoing testing (Sagem)

spectra are then finally refocused onto a large format (2k x 4k pixel) low-noise infrared detector array where they are registered and sent to the ground.

NIRSpec carries a total of six diffraction gratings and a prism as its dispersive elements. Depending on the source brightness and the astrophysical problem at hand, these allow the user to disperse the target light by different amounts, and separate adjacent wavelengths to a relative accuracy (or spectral resolution) of $\lambda/\Delta\lambda = R = 100, 1000$ or 2750 .

In addition to the MSA, a 3×3 arcsec Integral Field Unit and five fixed long slits are also available for detailed spectroscopic studies of isolated single objects and other specialised applications.

Another noteworthy feature of NIRSpec is the use of silicon carbide (SiC) ceramic as basic material for both the mirrors and the structural parts of the instrument. SiC is a unique material with a very high stiffness-to-mass ratio and a very high thermal stability expressed through its thermal conductivity to thermal expansion ratio. This

makes the material very suitable for low temperature optical applications. SiC was also used to build the ESA Herschel telescope and is the basic material for the complete telescope structure and mirrors of the ESA Gaia mission.

NIRSpec is being built by European industry to ESA's specifications and managed by the ESA JWST Project at

ESTEC. The prime contractor for NIRSpec is EADS Astrium in Ottobrunn, Germany. The NIRSpec detector and MSA subsystems are provided by NASA's Goddard Space Flight Center.

The MIRI Instrument

In contrast to the NIRCам, NIRSpec and the Canadian provided Tunable Filter instruments that operate exclusively in the near-infrared $1\text{--}5 \mu\text{m}$ wavelength range, the MIRI instrument on JWST is designed to sample the longer mid-infrared wavelengths at $5\text{--}28 \mu\text{m}$. The mid-infrared spectral region is important astrophysically for a number of reasons, not least of which is the ability of mid-infrared light to penetrate the dense interstellar dust clouds that enshroud star forming regions and make them impenetrable to study at shorter wavelengths.

As MIRI is the only instrument on JWST sampling mid-infrared wavelengths, its design is self-contained in that it carries both a camera mode for direct imaging and two spectrograph modes providing spectral resolutions of $R=100$ and $R=2000$ respectively. The MIRI mirrors and structure are made of aluminium throughout. The instrument mass is 100 kg.

One noteworthy feature of the MIRI camera is its novel coronagraphic mode.

Europe's Contributions to the JWST Mission

ESA's participation in the JWST mission was approved by the ESA Science Programme Committee in 2003. The four major European contributions to the mission are formalised in the Memorandum of Understanding on JWST signed by NASA and ESA in 2007:

- provision of the NIRSpec instrument;
- provision of the Optical Bench Assembly of the MIRI instrument through special funding from the ESA member states;
- provision of the Ariane-5 ECA launcher;
- manpower support to JWST operations.

In return for these contributions, ESA gains full partnership in JWST and secures full access to the JWST observatory for astronomers from Member States on identical terms to those of today on the Hubble Space Telescope. European scientists will be represented on all advisory bodies of the project and will be expected to win observing time on JWST through a joint peer review process, backed by an expectation of a minimum ESA share of 15% of the total observing time.

In this mode, placing the image of a star on a 'Quadrant Phase Mask' causes the light from the star to be dramatically attenuated, thereby allowing any planets orbiting the star to be searched for and imaged directly.

To limit the self-emission from the MIRI instrument and operate its three 1k x 1k SiAs detector arrays, parts of the MIRI instrument need to be cooled some 25° below that of the passively cooled near-infrared instruments to a temperature less than 10° above absolute zero. This is achieved by means of a dedicated mechanical cooler.

MIRI is being procured jointly by Europe and the USA. The MIRI Optical System is being built and funded by a consortium of ESA member states led by the United Kingdom and comprised of France, the Netherlands, Germany, Spain, Sweden, Switzerland, Denmark, Belgium and Ireland. Overall leadership of the European MIRI consortium rests with the European Principal Investigator, Dr Gillian Wright of the Astronomy Technology Centre in Edinburgh. The MIRI detector arrays and mechanical cry-cooler are provided by NASA's Jet Propulsion Laboratory.

The Technical Challenges of JWST

The original name of JWST – the Next Generation Space Telescope – can be understood literally. JWST is the first space telescope whose primary mirror is larger than the diameter of the launcher fairing, and the first mission to use lightweight construction techniques and active adjustment of its mirrors in space.

The large size of the satellite and the need to fit inside an Ariane-5 launcher fairing requires a number of deployable features. The main telescope and its 18 hexagonal mirror segments have two deployable wings hinged and rotated against the back of the central telescope. The secondary mirror is suspended on a tripod in front of the main mirror that is folded and rotated against the back of the primary mirror during launch. During launch, the telescope rests on the spacecraft at four

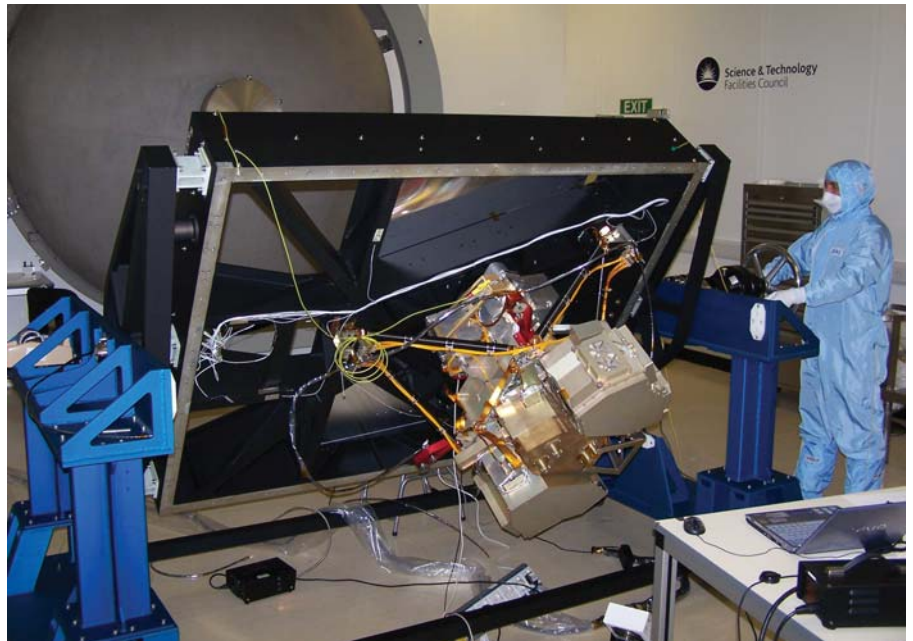

Verification Model of MIRI undergoing testing (MIRI EC)

corner points to transfer the launch loads, which also makes the geometry more compact.

The sunshade that separates the warm spacecraft from the cold telescope is impressive, reaching the size of a tennis court when fully deployed. The sunshade is stowed in two segments along the front and back of the telescope during launch. The solar arrays and communication antenna dish are also collapsed against the spacecraft body for launch. After separation from the launcher, the observatory will literally unfold itself like a butterfly from its cocoon (see a JWST deployment animation available at <http://sci.esa.int/jump.cfm?oid=41816>).

The JWST system design is strongly driven by thermal considerations. Sunlight must be kept off the telescope and instruments at all cost, and this is achieved with a sunshade made of five separate foils acting as a multi-layer insulation. The spacecraft, with its attitude control electronics, power regulation, communications systems and on-board data handling and processing system, is situated on the 'hot' side of the sunshade and operate at near-room temperature as on most other spacecraft.

The telescope and the instruments on the 'cold' side of the sunshade need to be kept below -240°C. This is achieved by physically separating the warm spacecraft from the cold observatory by means of a deployable tower that is activated after launch, thus giving a low parasitic heat transfer from the warm to the cold region. All electronics and instrument parts located in the cold region must have extremely low power dissipation in order to maintain the low temperatures.

The full complement of four instruments with a total mass of 570 kg has an average power dissipation of less than 0.5 W, less than a small bicycle lamp. The telescope and its instruments are passively cooled to below -240°C by exposing them to the deep-space environment at a temperature of -270°C. It takes four months to cool down the observatory after deployment of the sunshade. This matches very well the time it takes to reach the final orbit at L2, where observations can begin.

The Management Challenges of JWST

In the ESA/NASA cooperation on JWST, mutual responsibilities and obligations are defined at global level in

the JWST Memorandum of Understanding. The Joint Project Implementation Plan (JPIP) defines the mutual responsibilities and obligation in further detail, and also describes the management interaction and coordination between the two projects. A key assumption made in the JPIP is the principle of equivalence between the engineering and product assurance standards to which the two agencies each work. This makes it possible for the ESA and NASA contractors to work to standards they are familiar with.

The JPIP is based on a partnership and not a contractual relationship. No money flows between the two agencies. As a partner, ESA supports all the programme-level activities such as reviews and approval of all higher-level project documents. However, NASA is responsible for the overall mission system, and ESA works to interface and functional requirements defined by NASA. ESA is responsible for the NIRSpec and the MIRI Optical Systems. NASA delivers subsystems to both instruments according to interface and functional requirements defined by ESA. This makes the overall technical and programmatic situation rather complex

The guiding principle used in the definition of the ESA/NASA mutual responsibilities has been to identify 'Clean and Clear Interfaces'. This applies to both technical and management interfaces, and has probably been the most important aspect to ensure a smooth and efficient cooperation. An example is the delivery of detectors for NIRSpec and MIRI from NASA. Detectors, detector electronics, flight software, electrical and mechanical ground support equipment, calibration and qualification are the responsibility of NASA. This makes the detector systems fully independent subsystems and easy to manage from both a technical and programmatic point of view.

Working cultures are certainly different between ESA and NASA, and



JWST in launch configuration inside the Ariane-5 fairing



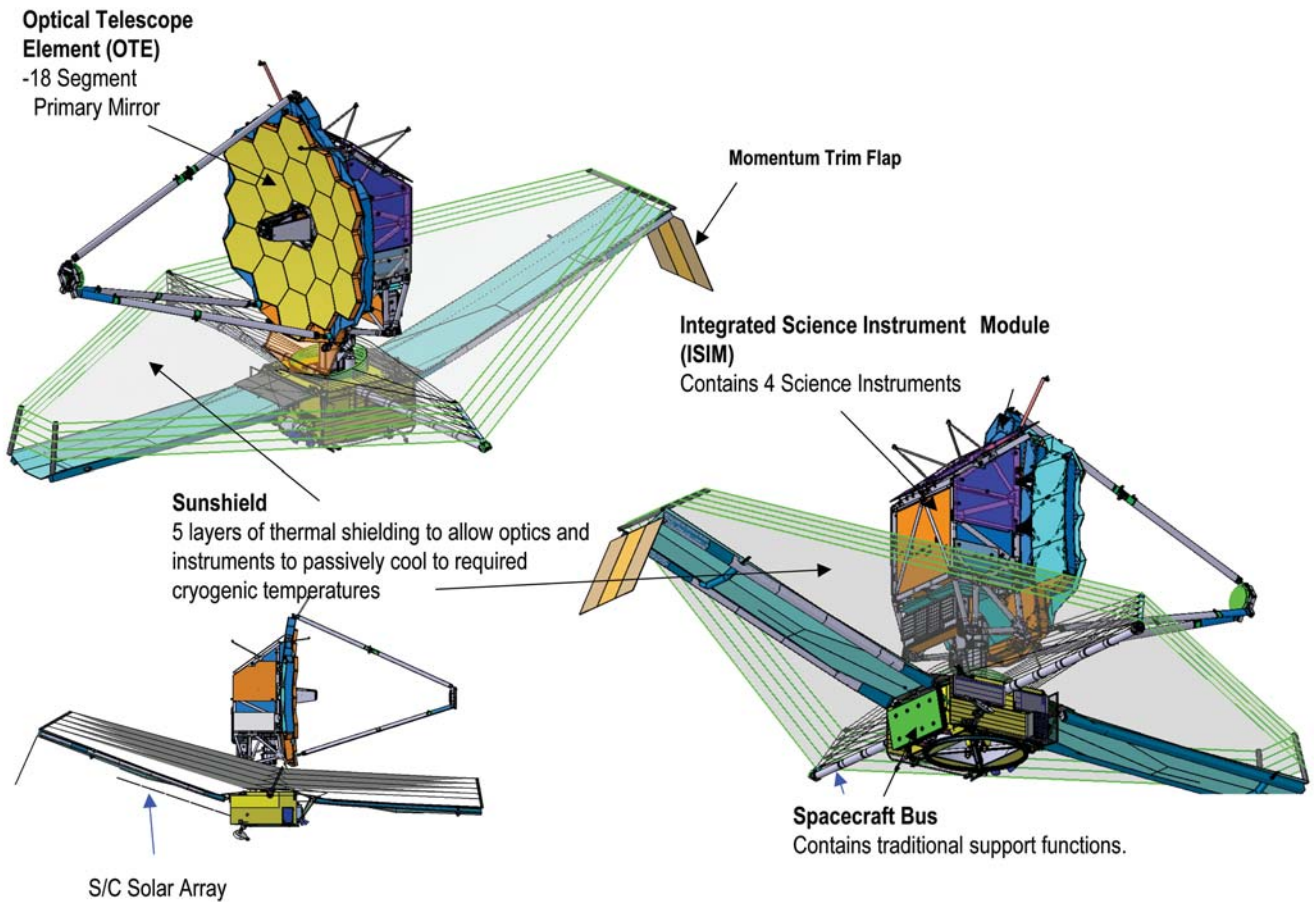

it is important that the two project teams on both sides of the Atlantic be conscious of this to avoid conflicts and irritation. The in-depth definition of deliverables: hardware, software, ground

support equipment and documentation captured in the JPIP has significantly mitigated conflict situations and smoothed the cooperation. It has been made clear from the beginning what was

expected from each party at the lowest possible level.

The ESA/NASA cooperation is further complicated due to the International Traffic in Arms Regulations (ITAR), which is a set of government regulations that control the US export and import of defence-related articles and services. Basically all space activities and products are considered defence-related. This makes it very difficult for a US company to share any detailed design information, analyses and test procedures with ESA. The exchange of information and service needs to be defined in a Technical Assistance Agreement (TAA), which is to be approved by the US Department of State (DoS). Typically, very strong provisos are applied by DoS, which precludes any exchange of detailed design information. This constraint makes it even more important to have 'Clean and Clear' interfaces, with a minimum of exchange of information required.

The JWST Technology Development Programme

JWST takes us outside the capabilities of today's technology and satellite design approach in several areas. Ten critical leading technologies were identified by NASA in the concept phase of the project. The leading technologies span a very wide range: mirror segment adjustability with nanometre accuracy, alignment of all 18 mirror segments, stability of the mirror segment support structure, large format and ultra-low noise near-infrared and mid-infrared detectors, mechanical coolers for MIRI and the Micro-Shutter Array for NIRSpec.

All technologies reached the required TRL-6 in spring 2007. TRL-6 requires a system or subsystem model or prototype demonstration in a relevant environment. This is an important achievement that allows the JWST project to progress to the implementation phase with the required technological developments in hand. A significant investment had been made early in the project development phase to achieve this.

To support the construction of NIRSpec, ESA also faced the need to develop new technologies in the field of high-performance mirrors and structures, which are compatible with use at -240°C . The development focused on qualifying silicon carbide (SiC) ceramic as the basic material for both the mirrors and the structural parts of NIRSpec.

Europe's Eyes on the Skies



The Proposal for a European
Space Surveillance System

Heiner Klinkrad

Ground Segment Engineering Department,
Directorate of Operations and Infrastructure,
ESOC, Darmstadt, Germany

Richard Tremayne-Smith

British National Space Centre (BNSC), London,
UK

Fernand Alby

Centre National d'Etudes Spatiales (CNES),
Toulouse, France

Detlef Alwes

Deutsches Zentrum für Luft- und Raumfahrt
(DLR), Bonn-Oberkassel, Germany

Space surveillance is the detection, correlation, characterisation and orbit determination of objects in space. At present, only the USA and Russia have this operational capability with a routinely updated space object catalogue. Plans are now being discussed for a future European Space Surveillance System and, for eventually, a 'Space Situation Awareness System'.

Introduction

While some European radar and optical facilities exist for tracking and imaging space objects, Europe has no systematic, operational capability for space surveillance, and is therefore strongly dependent on external information, mainly from the USA.

Following an ESA Council Resolution (ESA/C(89)24) calling for a risk assessment of spaceflight, two tasks were identified: the acquisition of space object data and the analysis of the feasibility European space surveillance capability.

The latter task became the responsibility of the European Coordination Group on Space Debris. Its members (BNSC, CNES, DLR and ESA) were asked to do a feasibility study for a

The EISCAT radar on Svalbard. This and similar radars could form the basis for a European space surveillance network (Y. Rinne)

Existing Optical Sensors



The ESA Space Debris Telescope at Tenerife, Spain (ESA)

Tenerife

ESA operates a space debris telescope on Tenerife that covers a sector of 120° of the GEO ring. From single observations, initial orbits can be derived which are generally adequate for re-acquisition of the object within the same night, and which can then be successively improved.

Technical specs: Telescope of 1 m aperture and 0.7° field of view, located on Tenerife. It uses a 2×2 mosaic of CCDs of 2048 by 2048 pixels each, with a detection threshold of +19 to +21 visual magnitude (corresponding to 15 cm objects at GEO altitudes).

The TAROT telescope of CNRS at Calern/France and in Chile (CNRS)

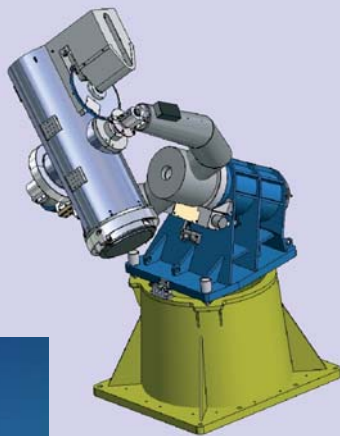

TAROT

CNES uses observation time of the TAROT telescope (Télescope à Action Rapide pour les Objets Transitoires) to survey the GEO ring. TAROT's primary mission is to detect the optical afterglow of gamma-ray bursts. A companion telescope, TAROT-S has been deployed in Chile.

Technical specs: Telescope of 25 cm aperture, and field of view of $2^\circ \times 2^\circ$. It is equipped with a CCD of 2048 by 2048 pixels for detections and follow-up measurements of objects up to visual magnitude +17 in and near the GEO ring.



The Starbrook telescope of BNSC at Cyprus (SpaceInsight)

Starbrook

The British National Space Centre (BNSC) has sponsored the Starbrook wide-field telescope as an experimental survey sensor since 2006. The telescope is located at Troodos/Cyprus, It can detect GEO objects down to 1.5 m sizes (visual magnitude of +14).

Technical specs: The telescope has an aperture of 10 cm, a field of view of $10^\circ \times 6^\circ$, and a CCD of 4008 by 2672 pixels.

The ZIMLAT telescope at Zimmerwald, Switzerland (AIUB)



ZIMLAT/ZimSMART

The Astronomical Institute of the University of Bern (AIUB) operates a ZIMLAT telescope. From its location in Zimmerwald, the telescope covers a sector of 100° of the GEO ring. The primary applications of ZIMLAT are astrometry and laser ranging. However, up to 40% of its night-time observations are used for follow-ups of GEO objects discovered by the ESA telescope. ZIMLAT was complemented in 2006 by the 20 cm ZimSMART telescope (Zimmerwald Small Aperture Robotic Telescope).

Technical specs: ZIMLAT telescope with aperture of 1 m and a field of view of 0.5° . A CCD of 2048 by 2048 pixels allows the detection of objects up to visual magnitude +19. The ZimSMART is dedicated to GEO survey, using a CCD of 3056 by 3056 pixels with a field of view of 4.2° .



The ZimSMART telescope at Zimmerwald, Switzerland (AIUB)

European space surveillance capability. A Space Surveillance Task Force was formed and its 2006 report, 'Space Surveillance for Europe – a Technical Assessment', defined the main criteria for a future European Space Surveillance System (ESSS).

These can be summarised as follows:

- full coverage of LEO (Low-Earth orbit (below 2000 km altitude)), GEO (Geostationary Earth orbit (35 786 ± 2000 km altitude)) and 12-hour, near-circular MEO (Medium Earth orbit) orbits; limited coverage of orbits outside these regions;
- autonomous build-up and maintenance of a catalogue of all observable space objects;
- detection, tracking, orbit determination, target correlation, and physical characterisation for objects in LEO, MEO and GEO with a reliability and sensitivity matching the one of the US Space Surveillance Network (SSN);
- estimation of orbit manoeuvres;
- detection of on-orbit break-up events and correlation with the source object(s).

Later, aspects of space situational awareness were studied:

- extended object characterisation attributes, including mission objectives and capabilities;
- well-defined accuracy and timeliness

of data products, dissemination and sharing;

- data security, confidentiality, integrity and high availability;
- incorporation of available national sensors.

Space Object Observation

In early 2006 (all population data in this article shall refer to Jan. 2006), the number of un-classified objects in the US Space Surveillance Network (SSN) catalogue was in the order of 10 000. These catalogue objects are typically larger than 10 cm in LEO and larger than 1 m in GEO. Due to sensitivity ranges, radars are primarily used for surveillance and tracking in LEO and optical systems for GEO. With 75.7%, the vast majority of catalogue objects reside in the LEO region. Another 8.7% of the catalogue objects are in or near the GEO ring. The remainder of the catalogue mainly belongs to the MEO region, which also contains the near-circular, semi-synchronous GPS and GLONASS constellation orbits near 20 000 km altitude.

Peak concentrations of catalogue objects exist at altitudes of 800 km to 1000 km and again around 1400 km. Peaks in the latitude distribution are located between 65° and 82°. As a consequence, a zenith-facing 'electronic fence' deployed in Europe at 50°N is able to observe almost 80% of the entire US

SSN catalogued objects. Hence, European latitudes are a good compromise between coverage of the orbit population and frequent station passes.

Assessment of a Proposed European Surveillance System

Ground-Based LEO Surveillance Concept

A survey of existing sensors (see pages 44 and 47), in combination with findings from several ESA studies, has led to the following core recommendations for a European Space Surveillance System (ESSS) radar design to cover the LEO region:

- radar design: bistatic continuous-wave radar operating at 435 MHz (with increased transmitter power, the cataloguing performance remains close to the technically optimal 600 MHz frequency);
- transmitter: four phased arrays (26 elements each with 16 kW transmitted power);
- receiver: four phased array receivers (1500 elements each).

It is expected that 98.6% of the US SSN catalogue and 96.1% of the more complete MASTER-2001 (Meteoroid and Space Debris Terrestrial Environment Reference (MASTER) model (ESA)) debris environment population larger than 10 cm can be detected and catalogued for a radar range of

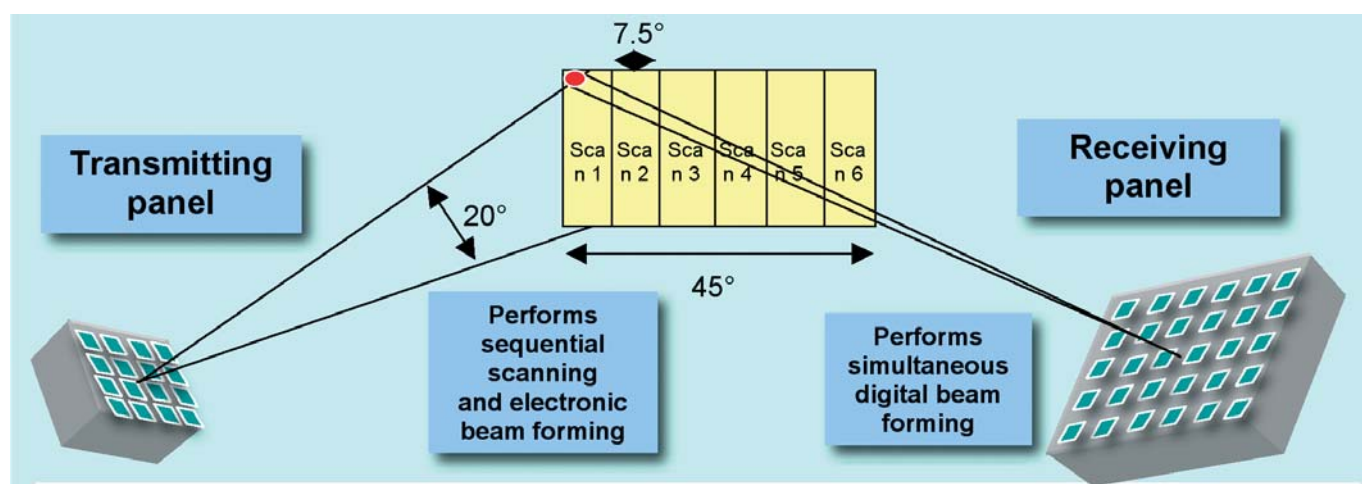

Concept of the proposed bistatic LEO surveillance radar (ONERA)

1500 km. The simulations done for the performance evaluation are based on ONERA's Surveillance System Simulation (S3) software, run over a simulation timespan of one month.

For the location of the bistatic LEO radar, two sites in Spain are considered: Pico Villuercas in Extremadura for the transmission and the Arenosillo military base in Andalucia for the reception. Spain constitutes a near-optimal deployment location due to sufficiently frequent sensor passes with acceptable observation gap times. A three-phase ESSS radar development is foreseen to extend over a period of five years. Its estimated costs at completion are €114.3 million. First operational test campaigns could begin three years after the start of the ESSS development.

Ground-Based GEO Surveillance

Concept

Due to large distances to the targets, the survey of this family of orbits is normally done with optical instruments. In an assessment study two different types of sensors were identified to be necessary:

- detection and tasking: 0.5 m telescopes with a wide field of view of 3° x 3°;
- survey: 1.0 m telescopes of a field of view of 1.2° x 1.2° (alternative: 0.5 m telescopes).

The proposed GEO survey strategy implies a continuous coverage of a strip of ±17° in latitude, centred on the equator. Each GEO object crosses this strip once within 24 hours. Since a single sensor cannot cover this strip continuously (due to visibility constraints and nighttime limitations), a network of low-latitude optical sensors equally distributed in longitude is required. The observation strategy uses a combination of survey observations (searching for new objects) and tasking observations (for initial orbit determination and orbit improvement).

The GEO sensors (telescopes) should be uniformly distributed in longitude, at sites of low latitude, with acceptable meteorological and visibility conditions.

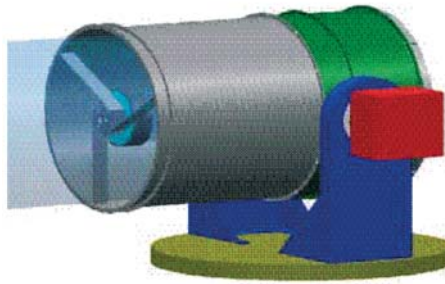

Concept of the proposed GEO observation telescope (AIUB)

A first network of sensors could consist of three sites for instance: Tenerife (E), Perth (AUS) and the Marquesas Islands (F). Each site would be equipped with a detection and tasking telescope, and with a survey telescope. The coverage of the GEO ring from these sites is about 85%. It can be extended to 95% by adding a fourth site at Cyprus. Each of these telescopes should be collocated with a telescope for tasked observations. The total cost of the GEO surveillance system is expected to be €16.2 million, distributed over five years.

Ground-Based MEO Surveillance

Concept

About 2% of the US SSN catalogue population is related to MEO objects in the vicinity of the 12-hour, near-circular orbits of navigation satellite constellations. This small, yet important population of space objects can be monitored down to size thresholds of 0.3 m to 1.0 m by means of two dedicated survey telescopes of aperture 0.8 m, with a field of view of 4.7°, for instance located on Tenerife and the Marquesas Islands. The proposed 0.5 m GEO tasking telescopes could also provide the needed MEO tasking capability.

The development and deployment cost of this MEO system will be approximately €8.0 million over a three-year period. Its cataloguing performance is expected to reach up to 95% of the US SSN MEO catalogue population.

Surveillance of Orbits outside LEO, MEO and GEO

The share of objects in the US SSN catalogue, which do not belong to the

LEO, GEO, or near-circular MEO class, is approximately 20%. In an operational space surveillance system, the survey of this class objects would have lower priority in view of the limited return for effort spent.

Surveillance Capabilities of On-Orbit Sensors

Preliminary assessments suggest that the most promising space-based telescope scenario* would be a survey of the GEO region from a Sun-synchronous low-Earth orbit. The proposed telescope could have an aperture of 20 cm and a conical field of view of 6°. The detection threshold would be at visual magnitudes of +15.8 in GEO. The unit price of this payload sub-system, including the in-orbit and ground-support hardware and software, is estimated to be €6.8 million.

Assessment of Cataloguing and Data-processing Performances

To assess the performance of a generic space surveillance system, an Advanced Space Surveillance System Simulator (AS4) was developed. It uses radar and telescope system models to translate sensor-specific field-of-view crossings of orbital objects into estimated instrument detection rates for a space object population according to ESA's MASTER-2001 space debris environment model. This MASTER-2001 population consists of 17 800 'real' objects larger than 10 cm (as opposed to about 10 000 US SSN catalogue objects of the same size), of which approximately 55% are in the LEO regime.

The AS4-simulated catalogue build-up process is self-starting, with no initial information required. In a test, the simulator was applied to 20 000 tracks, with 4 500 000 measurements, covering 93% of the entire observable population larger than 10 cm. After one day of simulated radar operations more than 90% of the LEO population was

* This observation concept was successfully demonstrated by the SBV (Space-Based Visual) sensor of 15 cm aperture on the American MSX satellite. For a limited time, it contributed about 20% of the SSN GEO catalogue.

Existing Radar Sensors in Europe

Fylingdales

The most powerful space surveillance sensor in Europe is located in Fylingdales (UK) and is operated by the British armed forces. Most of the activities are geared to the US Space Surveillance Network (SSN) early warning and space surveillance mission.

Technical specs: The Fylingdales complex consists of a high-performance 3-face, phased-array radar operating in the UHF-band. Technical details not openly available.



The Globus II X-band radar of the NIS at Vardø, Norway (NIS)

Globus II

A second facility associated with the US SSN is the Norwegian Globus II radar. It is located in Vardø, at the northernmost tip of Norway. Due to special bilateral agreements between the US SSN and the operators of Fylingdales and Globus II, data from these sites have so far not been available for unclassified use within Europe.

Technical specs: Globus II is an X-band mono-pulse radar, with a 27 m parabolic dish antenna, housed in a 35 m radome.

GRAVES

The French GRAVES system (Grand Réseau Adapté à la Veille Spatiale) is presently the only European installation outside the US SSN that can perform space surveillance in the classical sense. GRAVES is owned by the French Ministry of Defence and operated by the French air force. The system produces a 'self-starting' catalogue which can be autonomously built up and maintained. It is limited to objects of typically 1 m size and larger in low Earth orbits (LEO), with a total count of about 2200. Routine operations started in 2005.

Technical specs: GRAVES is based on VHF transmitters with four planar phased-array antennas of 15 m by 6 m each, which are located near Dijon. These tilted antennas are arranged in a south-facing semi-circle to deploy a conical detection fan up to altitudes of about 1000 km. Objects which pass through the detection volume reflect a fraction of the transmitted power, which is then received by a planar phased array of dipole antennas, arranged in a circular area of 60 m diameter, located at Apt, 380 km south of the transmitter. The GRAVES system determines orbital element sets from measurements of direction angles, Doppler, and Doppler rates for a large number of simultaneous targets.



The TIRA L and Ku-band radar of FGAN at Wachtberg, Germany (FGAN)

TIRA

The German FGAN Radar belongs to the Research Establishment for Applied Science at Wachtberg. In its tracking mode, the TIRA system determines orbits from direction angles, range, and Doppler for single targets. The detection size threshold is about 2 cm at 1000 km range. For statistical observations this sensitivity can be enhanced to about 1 cm, when operating TIRA and the nearby Effelsberg 100 m radio telescope in a bistatic beam-park mode with TIRA as transmitter and Effelsberg as receiver.

Technical specs: This is a mono-pulse tracking and imaging radar (TIRA) with a parabolic dish antenna of 34 m diameter, housed in a 49 m diameter radome. The radar uses L-band for tracking at 1.333 GHz, with 1 MW peak power, and Ku-band for Inverted Synthetic Aperture Radar (ISAR) imaging at 16.7 GHz, with 13 kW peak power. TIRA's range-Doppler ISAR imaging in Ku-band produce images with range resolutions better than 7 cm.



The Armor C-band radars on the French naval vessel Monge (DGA)



The Chilbolton S-band radar of RAL at Chilbolton, UK (RAL)

FS Monge

DGA/DCE, the Systems Evaluation and Test Directorate of the French Ministry of Defence, is operating several radar and optical sensors throughout France. The most powerful of these systems, Armor, is located on the tracking ship Monge. The two radars are dedicated to tracking tasks, based on high resolution angular and range data.

Technical specs: Armor C-band radars 5.5 GHz, 1 MW peak power

Chilbolton

The Chilbolton radar is located in Winchester, UK, operated by the Rutherford Appleton Laboratory (RAL). It is mainly used for atmospheric and ionospheric research. With a planned upgrade the radar will be able to track LEO objects down to 10 cm sizes at 600 km altitude.

Technical specs: Monopulse S-band (3 GHz) radar with a 25 m parabolic dish antenna

EISCAT

EISCAT is a network of European Incoherent Scatter Radars, with sites in Tromsø/Norway, Kiruna/Sweden, Sodankylä/Finland and Longyearbyen/Svalbard. The EISCAT system is mainly used for high-latitude ionospheric research. Its radar echoes, however, also contain information on LEO space objects. The Tromsø transmitter/receiver site is able to detect objects down to 2 cm sizes at altitudes of 500 to 1500 km. Since these measurements are insufficient to determine complete orbits, EISCAT is only of limited value for space surveillance.

Technical specs: 32 m antenna

catalogued. The final product is a database with identification and characterisation data for each unique object, estimated orbital parameters, and information on the orbit determination uncertainty. The achievable orbit determination position accuracy is on the order of 1–10 m in LEO, and 10–1000 m in GEO and MEO regions.

Dual-use Requirements on Space Surveillance Data

The term ‘dual use’ in the context of space surveillance data refers to civilian users, and military or state authorities. The information required by these communities can differ.

Next steps

These ESSS feasibility studies on the system design and operational concepts were performed with the intention to define a modular space surveillance system, which can be composed of sub-system building blocks with proven, low-risk technologies, and which can be used as a starting point for a more comprehensive ‘space situation awareness system’.

Existing European and ESA assets could be used to test and validate critical technologies and data processing concepts during the development and deployment of the proposed European Space Surveillance System. They could subsequently be

employed for dedicated surveillance tasks, for space situation awareness applications, and for dedicated national investigations and database maintenance, either stand-alone or in cooperation.

The preliminary technical, programmatic and cost information provided here is intended as an aid for interagency and intergovernmental discussions for a future European Space Surveillance System and, eventually, for a Space Situation Awareness System. This topic is intended to be discussed at the next ESA Council Meeting at Ministerial Level in 2008.



Welcome to Space

ESA's Strategy for Retaining European Space Competencies

Fiona Walsh & Paolo Donzelli
Human Resources, Directorate of Resources
Management, ESTEC, Noordwijk,
The Netherlands

Frank Danesy
Human Resources, Directorate of Resources
Management, ESOC, Darmstadt, Germany

Lesley Bonnefoy
Human Resources, Directorate of Resources
Management, HQ Paris, France

How often do you hear that the main asset of an organisation is its people? It sounds like a cliché, but this could not be more true for the European Space Agency. Our reputation of technical excellence has been built by generations of highly talented people, but finding new qualified candidates to continue this success story is becoming harder.

The success of ESA is largely due to a group of highly educated and motivated scientists and engineers, some recognised as world experts in their disciplines. Together with supporting specialist financial, legal and administrative staff, they make up the 'human resources' of ESA.

Historically there has always been a large and diverse pool of technical talent, both within European space industry and research institutes, from which ESA could draw to fill its vacancies. There has also typically been a very high interest from within the space sector in working at ESA.

However, finding qualified candidates for some specific technical areas is becoming increasingly difficult. Finding ourselves competing against our own

| | 2004 | 2005 | 2006 | 2007 |
|--------------|-----------|-----------|-----------|------------|
| Austrian | 2 | | 1 | 2 |
| Belgian | 2 | 2 | 4 | 7 |
| British | 7 | 7 | 14 | 26 |
| Canadian | 1 | 1 | 4 | 3 |
| Danish | 3 | | | 2 |
| Dutch | 2 | 4 | 1 | 9 |
| Finnish | | | 2 | 3 |
| French | 14 | 19 | 19 | 33 |
| German | 17 | 14 | 25 | 36 |
| Greek | | 2 | 1 | 5 |
| Irish | 2 | 2 | 1 | 2 |
| Italian | 11 | 6 | 8 | 16 |
| Norwegian | 2 | | | 2 |
| Portuguese | 1 | 3 | 3 | 5 |
| Spanish | 7 | 11 | 1 | 7 |
| Swedish | | | 4 | 2 |
| Swiss | 1 | 1 | 2 | 4 |
| Total | 72 | 72 | 90 | 164 |

Number of staff recruited into permanent posts by nationality from 2004

partners in the search for talent, we have introduced a number of internal and external measures to tackle these issues.

Market Forces

For some years now, Europe has been witnessing a relative decline in the number of university students enrolling in engineering and scientific disciplines. The Organisation for Economic Cooperation and Development (OECD) published a Policy Report in May 2006 in which it evaluated student interest in science and technology studies.

According to this report, most OECD economies have experienced a large increase in the number of students in higher education over the past 15 years, but the proportion of these students in science and technology has steadily decreased during the same period. Some disciplines, such as mathematics and physical sciences show particularly worrying trends*. This has a clear impact

on the number of engineers and scientists entering the employment market.

In the global arena, the competition to find talent is becoming fierce. There are new space powers, such as China and India, which are rapidly gaining expertise. There has been growth within the Russian space programme and new exploration initiatives from the United States. Due to this globalisation of the space sector, the sustainability and competitiveness of European industry is more at risk than ever before. Despite significant restructuring, there has been pressure on the profitability of the European space industry and consequently a reduction of the workforce.

Competition in the employment market in general to hire and retain the best talent is increasing. Large companies such as EADS, Siemens, Alcatel

* Organisation for Economic Co-operation and Development Global Science Forum, Evolution of Student Interest in Science and Technology Studies Policy Report, May 4, 2006

and Daimler AG, for example, make a great effort to gain the attention of potential pools of talent and market themselves as employers of choice.

The nature of the required technical skills at ESA is also evolving. We have had to reinforce competencies associated with co-funded ESA-European Commission (EC) security related programmes, like Galileo and Global Monitoring for Environment and Security (GMES). ESA now participates in developments for the commercial market, such as AlphaSat, Small Geo and Hylas.

The ESA Director General's 'roadmap' for the agency (Agenda 2011) also promotes the importance of integrated applications based on a multi-disciplinary approach as an alternative to the single-system approach that ESA adopted in the past. All these evolutions contribute to a changing demand for certain skills, such as architecture design, software engineering, systems engineering, operations, multi-domain modelling and simulation of complex systems.

Recruitment Trends

In 2006, we advertised approximately 336 vacancies and 12% of these had to be re-issued, mainly due to a lack of qualified candidates. In some cases, the chosen candidate declined the offer and there was no suitable back-up candidate. In some extreme cases, re-issuing the vacancy was necessary following two unsuccessful rounds of interviews.

One of our recruitment challenges at ESA stems from a policy to maintain an appropriate balance of nationalities from our Member States. The number of external candidates hired from 2004-07 can be found by nationality in the chart (above left). Candidates who are nationals from ESA's over-represented countries are not typically invited for the first round of interviews. This dramatically reduces the initial pool of qualified allowable candidates. However, nationals from over-represented countries can be considered if a second round of interviews is necessary.

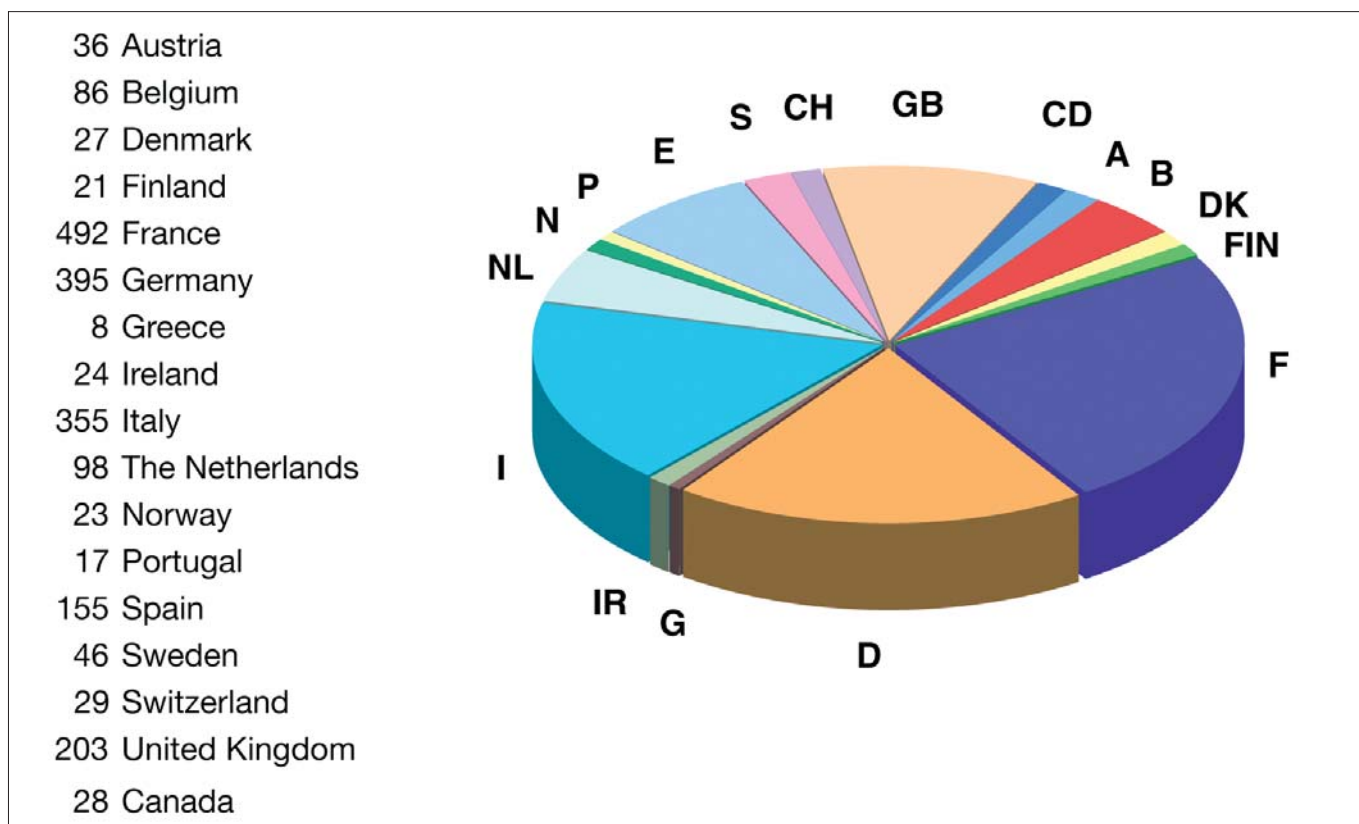

Total ESA permanent staff in 2008, proportional by nationality

An additional consideration for ESA is that of gender equality. We introduced an Equal Opportunities and Diversity Policy in 2002, and one of the main objectives was to increase the number of women in scientific and technical positions. There has been an 8% increase in the total number of women in professional positions between 2006 and 2007 and the number of women in senior management positions has increased by 35%.

There are ten directorates at ESA; five programme and five support directorates. Two of the support directorates, the Directorate of Technical and Quality Management (D/TEC) and the Directorate of Operations and Infrastructure (D/OPS) accounted for nearly 50% of all vacancies issued in 2006. Of the 82 staff hired for D/TEC, most were for technical posts and 83% of the vacancies were filled with external candidates. D/TEC is typically the entry point for many newcomers to ESA as well as being the

heart of ESA's research and development activities. This is therefore the Directorate most affected by the shortage of competencies.

The technical specialisms in short supply in D/TEC are power supply and power conditioning engineering, tracking, telemetry & command, radio navigation, component engineering, telecommunication engineering, on-board software and quality and product assurance. For D/OPS the critical areas are operations engineering and flight dynamics. For most programme directorates, there is a critical shortage in systems engineering with a multi-disciplinary approach. Fulfilling the requirements in these areas continues to be a concern for us in the foreseeable future.

Acquiring Competencies

Until now, we have relied almost exclusively on our external career web site to attract candidates. The vacancies page still remains one of ESA's most

visited pages on the ESA Portal, receiving an average of 27 000 hits a month. Employees in space industry, research institutes and universities in Europe and Canada dedicated to space research and development generally know ESA, because they often work on ESA funded programmes. This 'inside knowledge' ensures a familiarity of ESA not normally found in other organisations. An active effort in employer branding was therefore not necessary in the past. Due to an increasingly tight labour market in recent years, however, it has become necessary to find alternative and more proactive ways to attract talent and to ensure that critical competencies can be shaped or cultivated from ESA's existing skills base.

Internal Solutions

Training and Development of Current Staff

We have always recognised the importance of training and developing our



Shrinking world: In the global arena, competition to find talent is becoming fierce

staff members. An extensive catalogue of courses and programmes has been designed and implemented to enhance employees' technical and managerial proficiency and to support career development.

There is now a much greater emphasis placed on training with for example the proposed mandatory training for newcomers. With this initiative that is now being piloted in (D/TEC), all new staff will complete a training programme within the first two to three years after joining ESA. It includes information sessions on internal ESA processes, such as finance and procurement, as well as courses on space systems engineering. It also includes management development courses for newly appointed managers.

Training alone cannot solve the shortage of certain competencies. It is only through hands-on experience that someone can become proficient in a particular area. Many managers unfortunately are not always able to

provide on-the-job training to the extent necessary for inexperienced staff to obtain the skills and competencies required to do the job.

Knowledge Sharing

The ESA 'A5 Ad Personam' scheme, established in 2000, has established a group of experts within ESA to cover the spectrum of space-related technical and scientific domains relevant to ESA's programmes (A5 is a level in ESA's grade system). An added benefit of this scheme is to provide recognition and career advancement for staff who have built up technical or scientific expertise. Before this, the only possibility for people to progress to higher grades was to apply for A5 posts with managerial responsibilities. Now staff can continue developing further within their area of expertise without having to take on managerial tasks.

With this recognition also come certain obligations and responsibilities. One of the criteria on which 'A5 Ad

Personam' applicants were judged was their proposal for a personal contribution to the future role of ESA. This implies an obligation to lead and continue to actively contribute to further technical or scientific achievements in areas of relevance and major interest for ESA. During 2008, each A5 Ad Personam member will develop and deliver a general lecture for ESA staff about the specialisation for which they have been recognised.

These knowledge transfer initiatives will help to address the so-called 'brain-drain' when experienced staff retire, by retaining some of the accumulated experience and know-how and preserving some critical competencies that might otherwise be lost.

Reorientation of Young Graduate Trainee Scheme

ESA's Young Graduate Trainee (YGT) Scheme, operating successfully for over 20 years, offers recent graduates a unique opportunity to gain one year of valuable hands-on experience in engineering or scientific work. Trainees leave after this year to work within European space industry, but many ex-trainees then return to ESA with 5–10 years of industry experience, better equipped to manage and monitor industrial contracts.

One way to overcome some of the shortages in ESA's core competencies in the short to medium term could be a revision of the existing YGT Programme. One of the options being considered is to provide a greater number of training opportunities in the technical areas where we are experiencing critical shortages. The best of these trainees could be offered a second year either in ESA or within industry.

A cooperation agreement could be reached with various industrial partners with the understanding that after a second year in industry, the trainee would return to ESA for further training and eventual hire. A dedicated allocation of advanced recruitment opportunities could be set aside to ensure that ESA can further benefit

from their acquired expertise. This programme could be further strengthened by the inclusion of a training plan covering ESA's core processes.

External Solutions

Exchanges with Industry and Secondments

A series of staff exchange programmes between ESA and space industry are currently being evaluated. Following the signing of a secondment convention between ESA and EADS, we are now pursuing possibilities to exchange staff between the two organisations. Similar conventions could be discussed with other corporations, such as Thales Alenia.

These exchanges are aimed at developing highly competent staff members, whose experience, knowledge and skills will be further strengthened by this experience. The main focus of this secondment exercise will focus primarily on ESA staff in their early careers or whose background does not yet include industrial experience. In exchange, ESA is discussing with EADS the possible placement of experienced professionals who could provide support in areas such as satellite operations.

There are also an increasing number of staff being seconded to and from other affiliated organisations, including

DLR, The Group on Earth Observations (GEO), the French Aerospace Research Centre (ONERA), the European Commission and European Southern Observatory (ESO). These secondments are designed for the mutual benefit of both parties.

Coverage in Media

Whenever appropriate, ESA advertises in newspapers, specialised trade publications and job web sites. Although this type of advertising has higher costs associated with it than ESA's usual methods, these campaigns reach a market with a total circulation of over two million readers.

In November 2007, we carried out a widespread media campaign and placed a number of print and web advertisements in prominent newspapers and publications in countries where we have an under-representation of staff, including Germany, UK, Belgium, Norway, Switzerland and Luxembourg.

The results of this campaign will show its benefits in early 2008, both in quantitative and qualitative terms, but in the past these types of campaigns have further increased the number of applicants who apply.

We also promote ESA by contributing articles to the careers sections of European newspapers, such as the German *Frankfurter Allgemeine Zeitung*

and the *Süddeutsche Zeitung*, and the UK's *The Independent* and *The Guardian*. In addition to these activities, we also organise and participate in a number of workshops, round-table discussions and international career days in coordination with foreign ministries.

Job Fairs and Promotional Campaigns

We have been taking part in organised careers fairs since 2001. The first fairs were in Germany and Switzerland, but we now attend around 15 fairs per year across Europe. Here we can make contact with an average of 70–120 potential candidates per day at most job fairs.

More than 30 promotional campaigns have also been organised since 2002 in Germany and Switzerland, as a co-operative effort between ESA, the German Aerospace Center (DLR), the Swiss Space Office (SSO), representatives from space industry and the relevant foreign ministries. These campaigns have reached thousands of young professionals interested in working in the space sector and, more specifically, for ESA.

All these efforts have had quantifiable results. According to a leading European institute specialising in human resources marketing, in annual surveys to determine which employers are considered the most attractive, we did not even rank among the top 100 companies up to 2002. Since 2003, ESA is consistently ranked in the top 20.

Outlook

ESA cannot afford to be complacent as competition will only increase. These internal and external initiatives will help to ensure the continuity and availability of a highly qualified and motivated workforce that will, in turn, play a critical role in strengthening the position of ESA in the European space sector. These initiatives must be closely monitored and modified where necessary, with new ones being introduced as market pressures change. All this is necessary to maintain the reputation of technical excellence for which ESA has become known. 

The key to success: ESA's initiatives will help to ensure the continuity of a qualified and motivated workforce



Programmes in Progress

Status end-December 2007



| PROJECT | |
|---|--------------------------|
| SCIENTIFIC PROGRAMME | SPACE TELESCOPE |
| | ULYSSES |
| | SOHO |
| | HUYGENS |
| | XMM-NEWTON |
| | CLUSTER |
| | INTEGRAL |
| | MARS EXPRESS |
| | SMART-1 |
| | DOUBLE STAR |
| | ROSETTA |
| | VENUS EXPRESS |
| | HERSCHEL/PLANCK |
| | LISA PATHFINDER |
| | GAIA |
| JWST | |
| BEPICOLOMBO | |
| EARTH OBSERVATION PROGRAMME | METEOSAT-5/6/7 |
| | ERS-2 |
| | ENVISAT |
| | MSG |
| | METOP |
| | CRYOSAT |
| | GOCE |
| | SMOS |
| | ADM-AEOLUS |
| | SWARM |
| | EARTHCARE |
| COMMS/NAV. PROGRAMME | ARTEMIS |
| | ALPHABUS |
| | SMALL GEO SAT. |
| | GNSS-1/EGNOS |
| TECHNOL. PROG. | GALILEO |
| | PROBA-1 |
| | PROBA-2 |
| HUMAN SPACEFLIGHT, MICROGRAVITY & EXPLORATION PROGRAMME | SLOSHSAT |
| | COLUMBUS |
| | ATV |
| | NODE-2 & -3 & CUPOLA |
| | ERA |
| | ISS BARTER & UTIL. PREP. |
| | EMIR/ELIPS |
| | MFC |
| | ASTRONAUT FLT. |
| | AURORA CORE |
| EXOMARS | |
| LAUNCHER PROG. | ARIANE-5 |
| | VEGA |
| | SOYUZ AT CSG |

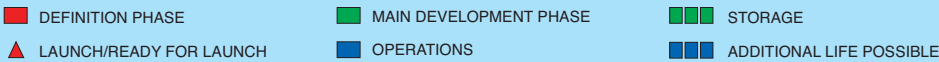
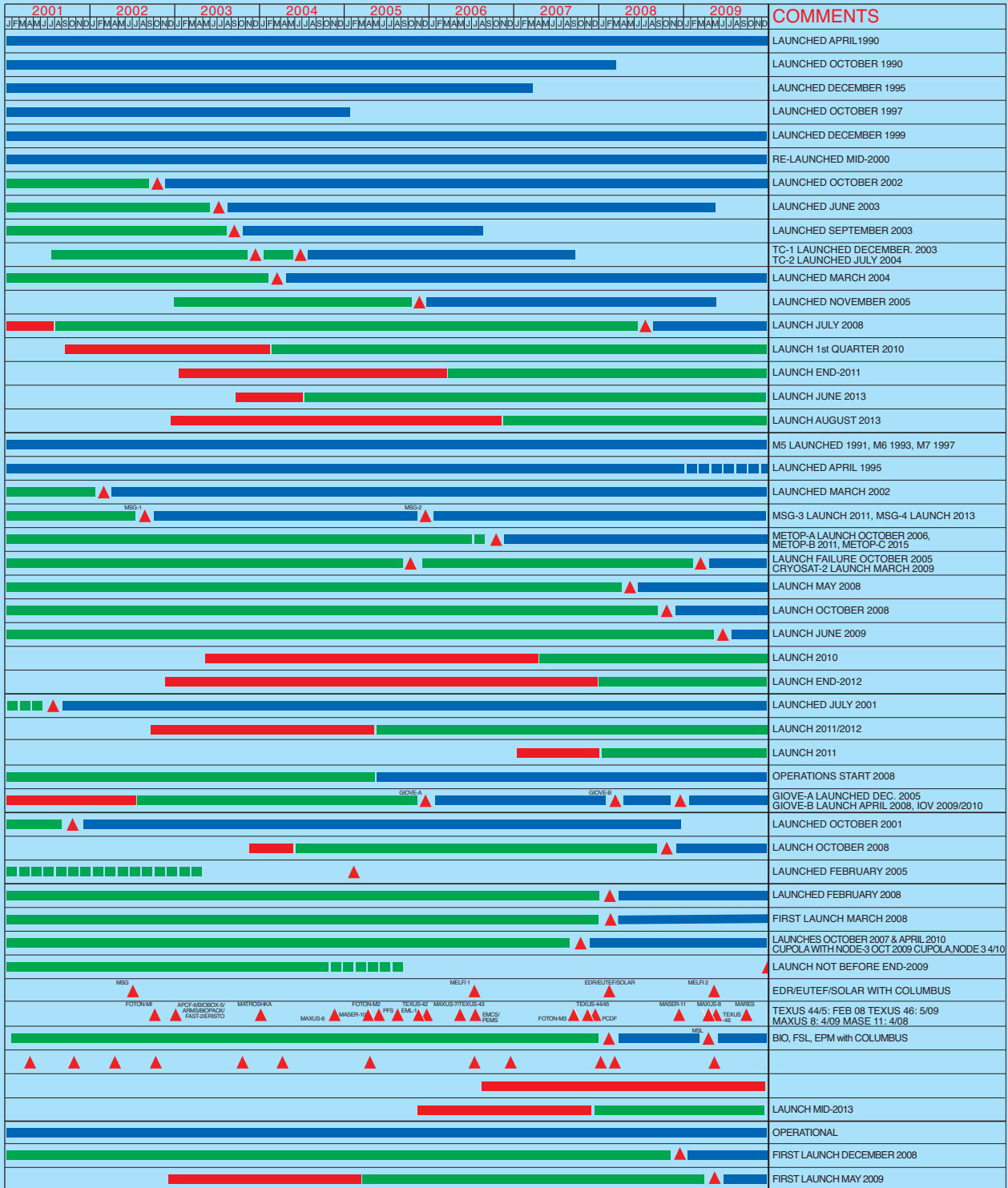

HST

Hubble has resolved some strange objects nicknamed 'blue blobs' and found them to be brilliant blue clusters of stars born in the swirls and eddies of a galactic collision 200 million years ago. Such 'blue blobs' – weighing tens of thousands of solar masses – have never been seen in detail before in such sparse location.

The 'blue blobs' are found along a wispy bridge of gas strung among three colliding galaxies, M81, M82 and NGC 3077, about 12 million light-years away from Earth. This is not a place astronomers expected to find star clusters, because the gas filaments were considered too thin to accumulate enough material to actually build this many stars. The star clusters in this diffuse structure might have formed from gas collisions and subsequent turbulence, which locally enhanced the density of the gas streams. Galaxy collisions were much more frequent in the early Universe, so 'blue blobs' should have been common. After the stars burned out or exploded, the heavier elements forged in their nuclear furnaces would have been ejected to enrich intergalactic space.

The so-called 'blue blobs' discovered by Hubble can be seen in the three insets under the visible image on the right (NASA/ESA)

Ulysses

Early on 15 January, at the start of a routine test in preparation for the next phase of the Ulysses mission, communication with the spacecraft via the on board X-band transmitter was lost.

As a result, the Spacecraft Operations Team declared a 'Spacecraft Emergency' in order to obtain additional ground station coverage from NASA's Deep Space Network (DSN).

The team was then able to send the commands needed to switch to the S-band transmitter, and establish stable communications, albeit at a low bit rate.

Subsequently, the bit rate was increased to 1024 b/s using a 70 m DSN station and the data recorded on board the spacecraft during the anomaly could be played back.

Since the spacecraft is in a very stable configuration and there are no power or thermal concerns, the Ulysses project ended the emergency status late on 16 January and Ulysses is now in 'Safing Mode'.

SOHO

Bright plumes in extreme ultraviolet and soft X-ray emerging from polar coronal holes have been of interest for nearly two decades. It was proposed that they might contribute to high-speed solar wind streams. On the other hand, could they be cooler material with no connection to the plasma sampled at high latitude by Ulysses? The SUMER team carried out a new series of polar plume observations during two campaigns in cooperation with the Japanese spacecraft Hinode and NASA's STEREO mission.

From these observations the 3D-plume geometry could be derived and plasma diagnostics confirmed that plumes have higher electron densities than their environment. The observations furthermore suggest that the plume contribution to the fast solar wind is relatively small. This work is being continued and extended by an International Space Science Institute (ISSI) study team.

On 4 January 2008, SOHO observed the first sunspot of the new solar cycle; see www.esa.int/esaCP/SEMT1J3MDF_index_0.html.

SOHO captures the first sunspot of the new solar cycle (ESA/NASA)

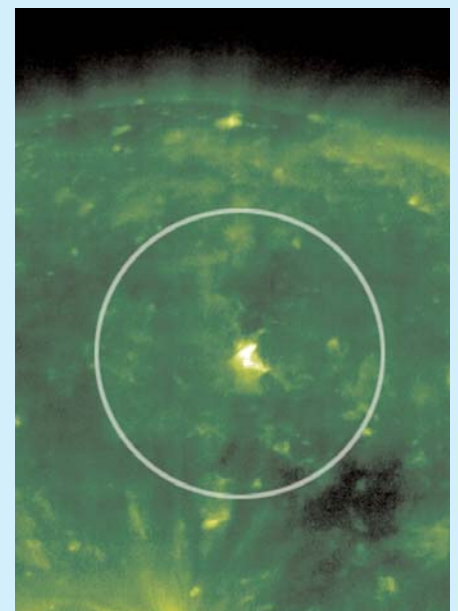
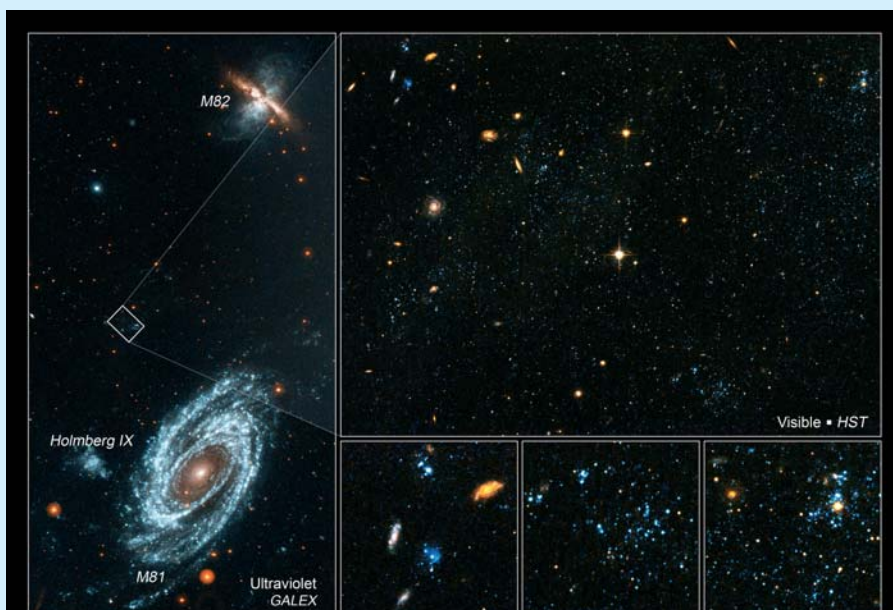

Cassini-Huygens

The first special volume of *Planetary and Space Sciences* on Huygens' results was published in November 2007 (Vol. 55 Iss. 13). Thirteen further papers, accepted for the second volume planned for mid-2008, are available at:

www.sciencedirect.com/science/journal/00320633.

The first radar observation at Titan's southern latitude was obtained on 20 December 2007. The synthetic aperture radar image covers the south pole of Titan. A few dark features seen in the image are interpreted as lakes and may correspond to dark features first identified by the Imaging Science Subsystem (camera) in June 2005. Their very dark appearance in the radar image suggests that they are probably filled with liquid methane. Other apparently empty lake basins are seen elsewhere in the radar image. Based on this very first observation at southern latitudes, there appear to be fewer filled lakes near the south pole than seen in a typical region near the north pole. This may support the theory put forward that lakes are filling in and evaporating with a seasonal cycle: methane fills the lakes during the winter (it is currently late winter in the northern hemisphere) and evaporates during the summer (it is currently late summer in the southern hemisphere). Further radar images of the southern latitudes are planned in the next few Titan flybys.

XMM-Newton

A study was done by Guedel et al. on the detection of hot plasma pervading the extended Orion Nebula, and a related article has been published by *Science Express*, which provides electronic publication of selected science papers in advance of print (29 November 2007 issue). The nearby giant molecular cloud in Orion hosts several thousand stars of ages less than a few million years, many of which are located in

or around the famous Orion Nebula, a prominent gas structure illuminated and ionised by a small group of massive stars (the Trapezium). Guedel et al. present X-ray observations obtained by XMM-Newton revealing that a hot plasma with a temperature of 1.7–2.1 million K pervades the south-west extension of the nebula. The plasma flows into the adjacent interstellar medium. The authors believe that this X-ray outflow phenomenon must be widespread throughout our galaxy.

The XMM-Newton Gallery is a collection of astronomical images and spectra obtained with XMM-Newton (http://xmm.esac.esa.int/external/xmm_science/gallery/public/). The images can be displayed in the latest version of Google Earth in association with the celestial target objects. At the time of writing, the corresponding Google format (KML) file had been downloaded about 2400 times from the XMM-Newton SOC home page (http://xmm.esac.esa.int/external/xmm_science/gallery/images/xmm_gallery.kmz). The XMM Newton Gallery is also listed on the 'Google Earth' web page as one of the 'featured files in the Google Earth Gallery' in category 'Google Earth KML: Sky', see http://earth.google.com/gallery/kml_listing.html#csky#s1#e10.

Cluster

New evidence that Coronal Mass Ejections (CMEs) can impact the acceleration of matter near the border of the magnetosphere to speeds higher than 1000 km/s was recently published in *Geophys. Res. Lett.* On 25 November 2001, during the passage of a CME at Earth, the four Cluster satellites were skimming the border of the magnetosphere (magnetopause) in a region called the 'magnetosheath', when they detected accelerated plasma up to speeds of 1040 km/s, while the ambient solar wind speed was only 650 km/s. This study compared observations from the four Cluster satellites with global simulations of the magnetosphere. The acceleration process

that was found, which interestingly is not related to magnetic reconnection but based on magnetic forces, predicted an altered coupling of these high-speed flows with the magnetosphere.

Double Star

Contact with TC-2, which was lost in early August 2007, was successfully re-established in November. The satellite is in good shape and the European instruments have been successfully switched on. Good data were obtained in December and early January.

Integral

Integral has discovered an asymmetric distribution of positron annihilation emission in the galactic disc (Weidenspointner et al. in *Nature*). The observed imbalance matches the distribution of a population of bright, hard, low-mass X-ray binary systems and suggests strongly that these binaries are churning out at least half of the antimatter, and perhaps all of it. The reported Integral detection of an 'annihilation-asymmetry' represents a significant step towards a solution for one of the major outstanding problems in high-energy astrophysics. For more details, see www.esa.int/esaSC/SEMKT2MDF_index_0.html.

Following a recommendation from the Science Working Team, the pattern of pointing positions on the sky that Integral performs has been slightly modified in order to further reduce systematic effects visible in deep sky mosaic ISGRI images.

Mars Express

'The European Mars Science and Exploration Conference – Mars Express & ExoMars' took



Rosetta's view of Earth on 13 November 2007 (ESA/OSIRIS Team)

place on 12–16 November 2007 at ESTEC and was a great success. A total of 271 abstracts were received, which translated into 125 oral presentations and 146 posters. Overall attendance was over 300. The conference programme (including abstracts, posters and presentations) is available at: <http://sci.esa.int/science-e/www/object/index.cfm?fobjectid=41364>

Rosetta

On 18 October a trajectory correction manoeuvre was performed to 'fine tune' the approach trajectory to Earth on 13 November. The manoeuvre was extremely accurate and Rosetta passed by Earth at 20:57 UT at a distance of 5300 km over the South Pacific and at a speed of 45 000 km/h. A number of scientific observations were performed. The first pictures from OSIRIS as

well as the Navigation Camera were published as ESA Press Releases.

The scientific case for the Rosetta flyby of asteroid 2867 Steins in September 2008 has been prepared and the requirements for the operation of the scientific instruments discussed. Very few conflicts have been identified, all of which can be resolved. At its 23rd meeting, the Rosetta Science Working Team agreed on the science priorities for the measurements during the Steins flyby.

Venus Express

The 29 November issue of *Nature* contained a special section with nine papers on the results of Venus Express and two additional related articles. In addition, a well-attended press conference was held in Paris the day preceding the issue. These two events led to

a large number of reports in the press, on radio/TV and on the internet. In particular, findings relating to the similarities and differences between the climate evolution of Venus and that of Earth attracted much attention. The escape of water from Venus and the existence of lightning were also referred to frequently.

Akari

Following the exhaustion of its cryogen at the expected time in August 2007, warm phase performance verification has started based on observations of standard stars. An orbit-change manoeuvre was successfully performed at the end of November to re-establish a Sun-synchronous orbit. Once the detector temperatures have stabilised, a focus adjustment will be performed and the performance evaluation completed. A Call for Observing proposals is expected to be issued this Spring.

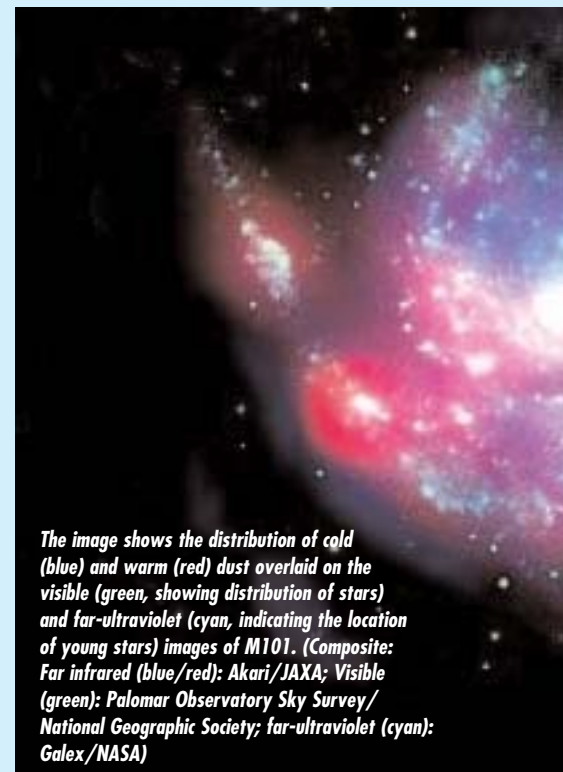

The image shows the distribution of cold (blue) and warm (red) dust overlaid on the visible (green, showing distribution of stars) and far-ultraviolet (cyan, indicating the location of young stars) images of M101. (Composite: Far infrared (blue/red): Akari/JAXA; Visible (green): Palomar Observatory Sky Survey/National Geographic Society; far-ultraviolet (cyan): Galex/NASA)

The first results from Akari have been published as a special issue of the *PASJ* journal.

Akari observed M101, a beautiful spiral galaxy located about 23 million light-years away in the constellation Ursa Major (the Big Dipper or Great Bear). Akari revealed giant star-forming regions, located along the outer edge of the galaxy. This is unusual because star formation is generally more active in the central parts of spiral galaxies. The evidence points to M101 having experienced a close encounter with a companion galaxy in the past. The active star formation would have been triggered by the gas dragged out from the companion, falling onto the outer edge of M101 at approximately 150 km/s.

Hinode

The 7 December issue of *Science* contained nine papers on Hinode, including a cover



image. One of the papers presented evidence for the presence of Alfvén waves in the chromosphere strong enough to power the solar wind, another one for the existence of Alfvén waves in solar X-ray jets. Two of the nine papers have a lead author from Europe. Another special issue, comprising 43 papers with initial results from Hinode, was the 30 November issue of *PASJ*.

A German-Norwegian team of scientists studied the boundary layers of magnetic elements in the solar photo-sphere using the spectro-polarimeter of the Solar Optical Telescope. The extremely high resolution of their data (the best ever achieved in polarimetric data) allowed them observationally to confirm a long-standing theoretical prediction and demonstrate that electric current sheets induced by magnetic boundary layers are common in the photosphere.

COROT

A press event arranged by the Paris Observatory on 20 December was very well reported across France. Featured prominently in this press release was a very interesting object discovered during the first long pointing in the galactic centre direction. In this light curve, displaying uninterrupted data over 146 days, one sees a newly-discovered planet orbiting very close to an active star. The light curve also reveals that there are two groups of star spots on the surface of the star at different latitudes, which rotate differentially. Even the 'beats' of the two rotational periods are easily seen in the light curve.

Herschel/Planck

The integration sequence of both Herschel and Planck is nearly complete and the acceptance test phase has started. All instrument flight model units have been delivered to the two spacecraft and have already been integrated.



Herschel arrives at ESTEC

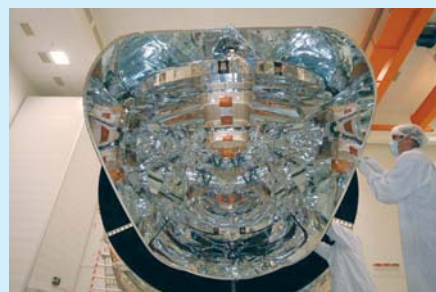

Planck during integration

Following the mechanical integration of the Herschel instrument focal plane units to the optical bench in the cryostat and an electrical verification of their functionality, the cryostat has been finally closed. The Flight Model spacecraft was transported to ESTEC in early January, and the spacecraft will stay there for the rest of the acceptance test campaign. A bake out will be directly followed by the cooldown and filling with helium. In parallel with the conditioning of the cryostat for the following test phases, the satellite functional test programme has already started.

For Planck, integration of all flight hardware has now been completed. The mechanical test campaign with sine vibration testing and acoustic noise testing was successfully completed in the last days of the year. Next are the integrated system tests in early January.

The ground segment development on the mission operation side in ESOC and the science ground segment in ESAC and the instrument centres is well underway, in preparation for the upcoming system validation tests.

With these final test campaign activities, the programme is moving towards launch, currently planned for end October 2008.

Lisa Pathfinder

The LISA Pathfinder development is proceeding with some delay to the schedule. The main engineering activities are related to the consolidation of the spacecraft design in preparation for the spacecraft CDR. In parallel most of the subsystems have also had their own subsystem CDRs, and many equipment suppliers have delivered their Flight Models (FMs). Unfortunately the science module FM structure was damaged by a fault during the static test. A new FM structure has been ordered, while the damaged structure will be repaired in order to allow parallel testing at system level and alleviate a further schedule delay. The on-board software development is proceeding: version 2.0 is being tested on the On-Board Computer Development Model.

The two European micropropulsion technologies (needle indium thrusters and slit caesium thrusters) continue their challenging development to prove the readiness of the technologies. Despite numerous problems, many have been solved and progress made in both technologies. It is now expected that the technology most suitable to the needs of LISA Pathfinder will be selected in the second half of 2008.

Regarding the LISA Technology Package (LTP), most of the subsystem CDRs and the LTP system CDR have been held successfully. In parallel all the LTP Electrical Models (ELM) have been built and delivered to Astrium GmbH for testing on the Real Time Test Bench. Progress has been made on all critical subsystems, e.g. the Inertial Sensor vacuum enclosure, the electrostatic suspension front-end electronics and the caging mechanism. For the latter, two different concepts have been breadboarded in order to choose the best design of the delicate interface between the Au-Pt Test Mass and the mechanism 'fingers'.

The launch is expected to take place in mid-2010.

Microscope

Progress has been made in the two critical domains: payload and micropropulsion. The payload went through successful PDR of the T-SAGE accelerometer allowing start of the development phase. The satellite control requirements were relaxed to allow consideration of cold gas as an alternative micropropulsion system to FEEPs.

A decision between the two candidate micropropulsion techniques is postponed to mid-2008, pending test results.

Gaia

The PDF concluded in mid-July 2007 left the project with major actions which were finally closed by the end of the year, confirming that the critical science performance requirements of the mission are met by the proposed design.

The competitive selection of about 80 subcontractors, which started in mid-2006, progressed very well and by late summer 2007 all subcontractors contributing to the production of the spacecraft had been selected.

The Multilateral Agreement concerning the Gaia Data Processing has been approved. The formal interfaces with the Data Processing and Analysis Consortium have been agreed and the DPAC Project Office is being implemented.

Preparations were under way for a further and very comprehensive test campaign into the radiation sensitivity of the CCDs. A dedicated test facility reached the final steps of commissioning. The test plan was established in consultation with the scientific community, and the test campaign will start in January 2008.

The first meeting of the Gaia Science Team in its new composition was held in December.

Ways to preserve the accumulated experience of the former members were discussed and a way forward agreed.

BepiColombo

Contract negotiations with the prime contractor Astrium GmbH were completed and the contract was signed mid-January 2008. The equipment procurement phase has continued and competitive Invitations to Tender have been issued for 40% of the equipment. Approximately a quarter of the subcontractors were selected. The project is undergoing a critical review of the mass growth and mass drivers and is investigating options to reduce the mass. The system design is being consolidated and a design freeze in preparation for the spacecraft PDR is now imminent.

The work on key technologies is continuing in anticipation of the selection of contractors.

The Science Requirements Review for nine instruments of the Mercury Planetary Orbiter have been successfully completed. The scientific performances were confirmed and the design definition is generally adequate. For the remaining two instruments this review is being completed.

The PDR of the Mercury Magnetospheric Orbiter is being held under JAXA responsibility. The board meeting has been postponed until mid-March to allow more time to address thermal, structural and separation dynamics subjects.

Solar Orbiter

The two parallel study contracts to advance the satellite concept and breadboard the Heat Shield technology, placed with Alcatel Alenia Space and EADS Astrium, have been completed. Both Sun Heat Shield breadboards were manufactured and tested successfully. This study also took the spacecraft system

design trade-offs and the accommodation of scientific instruments a step further, to prepare for the definition phase which will be performed in 2008 and 2009, as confirmed by the Science Programme Committee in November 2007. The spacecraft baseline design relies heavily on the re-use of technology and equipment from BepiColombo.

On the payload side, intensive work on the spacecraft technical interface definition with potential instrument providers has paved the way for progress on the payload accommodation, resources and interfaces. In October 2007 the Solar Orbiter Payload AO was released to the scientific community, with offers to be submitted by mid-January 2008.

ESA and NASA have analysed the possibility of implementing the Solar Orbiter mission together with NASA's Inner Heliospheric Sentinels as a joint programme of cooperative science. A joint Solar Orbiter/Sentinels Science and Technology Definition Team has defined this combined mission. Solar Orbiter will be launched by NASA and will carry significant US payload contributions.

In parallel, technology development activities have been initiated to advance the readiness level of the key elements such as a Sun-filter window, detectors and sun sensors.

LISA

The Mission Formulation activity performed by Astrium GmbH has produced very good results during the course of the year. The baseline design that includes steering of the whole optical bench plus telescope assembly has been confirmed.

The technology required by LISA has been further matured in the course of 2007, both in liaison with Member States in Europe and in the USA.

Data analysis was progressed in the framework of the Mock LISA Data Challenge that involved the worldwide LISA community.

The SPC confirmed LISA as one of the candidate missions for the Cosmic Vision L1 selection. The need to start the LISA implementation phase right after LISA Pathfinder has been recognised by the two partners, ESA and NASA. The respective roles and responsibilities of the partners are being revisited within the new financial boundaries of the L1 mission envelope for ESA and medium-sized mission envelope for NASA.

JWST

The JWST Optical Telescope has successfully passed its PDR. The Sun Shield PDR (planned for February 2008) is now the only outstanding review, allowing the mission-level PDR to take place in April 2008 as planned. The design and procurement of the spacecraft has also been initiated by NASA, with a focus on the mission-level PDR.

The NIRSpec CDR for the Micro-Shutter Array assembly has passed successfully. Fifteen flight standard Micro-Shutter Arrays have been produced so far (only eight arrays are needed for the flight model and flight spares programmes). The CDR for the five critical units still remains to be held before the instrument-level CDR in April 2008.

The instrument ceramic optical bench has successfully passed the first part of the proof load testing. It has now been delivered to the prime contractor for completion of the proof load testing.

The Verification Model (VM) of MIRI is presently undergoing the cryo-performance and thermal balance tests. First light using simplified optical stimuli has been seen by the imager and spectrograph channels and initial results are as expected. This test is supported by the actual flight SW developed by JPL. The bottom-up qualification review campaign is ongoing, with seven units still to be reviewed.

Flight detector chips have been down-selected for the MIRI imager and

spectrograph. Integration of the flight detector modules is ongoing. The screening method of the detectors was improved and confirmed the selection of flight detector chips.

The Ariane-5 Launcher RAMP (Revue d'Analyse de Mission Préliminaire) was successfully passed in December 2007.

GOCE

The environmental test campaign of the Satellite Proto-Flight Model (PFM) has been successfully completed at ESTEC. In October, the Satellite PFM was instrumented and installed in the Large Space Simulator Facility for the Thermal Vacuum/Thermal Balance (TV/TB) test that started on the 27 October. The Satellite PFM was operated continuously 24 hours a day, seven days a week for a period of 15 days in an environment simulating the extreme hot and cold conditions the satellite will experience when in orbit.

Following the TV/TB test, the preservation of the satellite sensor and actuator alignments was verified before the preparation of the next major activity: the mechanical acoustic test performed at the beginning of December. After this, the environmental test campaign was successfully completed at the end of December with the execution of the fit and separation checks with the launcher adaptor, umbilical connection and clamp-band system. In addition, the above-mentioned environmental tests were interleaved with functional tests needed to verify the various satellite operating modes. This completion of the environmental test campaign marks the achievement of a key milestone for the GOCE programme.

In October the Satellite Engineering Model Test Bench was transported to ESTEC in order to support the preparation of the final closed-loop functional tests of the Drag Free Attitude Control System (DFACS). Concerning the gradiometer, the manufacturing of a new set of the harness that connects the six

Accelerometer Sensor Heads to their respective electronics has been completed. This improved new harness has been mounted on the Gradiometer Core PFM, which is now ready to be integrated on the Satellite PFM in place of the Gradiometer STM.

The second part of the GOCE Ground Segment Overall Validation (GSOV) test was executed in December. Nearly all issues identified in the first part of this test campaign were resolved, proving that the ground segment elements are correctly working together in closed loop. Only a few minor issues remain to be checked before launch. The final Acceptance Test of the Calibration and Monitoring Facility was done in October. Furthermore, the Level 1 to Level 2 High-level Processing Facility of the European GOCE Gravity Consortium has successfully confirmed its launch-ready status by successfully completing the final full acceptance review of the overall system.

Finally, a System Validation Test dedicated mainly to the higher satellite functional modes has been successfully performed with exchange of commands/telemetry between ESOC and the Satellite PFM in ESTEC.

Cryosat-2

Integration of the satellite is well under way, with several units already installed on the nadir panel. The SIRAL antenna has already been delivered and the SIRAL itself will be shipped at the end of January. All the remaining equipment, with two exceptions, will be delivered in February. Currently activities are focused on integration testing, in which each piece of equipment is fully tested in the satellite environment. As the system is built up the team will move on to system testing.

The Final Integration Review was successfully held in January. All of the plans and procedures which will be needed during the coming test phases were scrutinised. The next review will be the Flight Acceptance Review, planned for December 2008, ready for a launch in March 2009.

The Ground Segment CDR was successfully held in December 2007. This review confirmed the interfaces and planning, which will call for extensive ground segment testing during 2008, leading up to the Ground Segment Readiness Review at the end of 2008.

SMOS

Vibration and acoustic tests at satellite level were passed without any problems, as well as the solar array deployment. Whilst the subsequent launcher adapter fit check and release test went very well as well, an interface problem was discovered, in that the spring pushers (on the launcher side) and the pusher plates (on the satellite side) were offset by 45°. Recovery actions are being investigated. Post-vibration functional tests have been completed without problem, to be followed by TV test commencing early February.

Ground segment development and integration/verification testing is proceeding, with a major milestone being imminent with the Data Processing Ground Segment Version 1 Factory Acceptance Test end of January.

ADM-Aeolus

The final preparations for the thermal vacuum test sequence of the transmitter laser were completed. This included a set of comprehensive characterisation tests to confirm stable laser operation in air over the expected operational temperature range and in two different mechanical orientations. Since the high-power output laser beam showed some focusing it was decided to re-align the power laser stage in order to avoid potential optical damage in the ALADIN instrument.

The first flight model of the transmitter laser assembly was installed in a thermal vacuum chamber at Galileo Avionica Firenze's premises. First operational tests of the laser in vacuum showed some unexpected



ALADIN laser assembly in vacuum test configuration



Transmitter laser assembly integrated in the thermal vacuum chamber

performance variations of the laser output energy and beam characteristics. These effects are currently under investigation.

Integration of the ALADIN optical bench assembly is complete and final alignment and optical characterisation tests are in progress.

The mechanical and electrical integration of the satellite platform at Astrium Stevenage is complete. An interim version of the Aeolus flight software was delivered to Astrium Stevenage, which allowed preparations for the formal system level tests at platform level to start.

The AO for the ADM-Aeolus Calibration/Validation activities was released

in October 2007. The AO was highly successful: fifteen proposals were received from institutions worldwide, including proposals from Canada, the USA, Japan and China. The proposal evaluation and coordination phase is due to finish with a final proposal selection on 15 March 2008.

The first flight campaign of the ALADIN Airborne Demonstrator (A2D) was completed in November 2007. Good quality flight data could be acquired for the first time. The second flight campaign is currently planned for April 2008.

Swarm

The major elements of the mission are in progress. The engineering model of the Electrical Field Instrument (EFI) has been manufactured and assembled. The performance and qualification tests are ongoing. A delivery to the satellite prime contractor Astrium GmbH is expected mid March for a test of compatibility on the real testbed of the satellite. The structural model of the optical bench, made in SiC material in order to support the three star trackers and the vector magnetometer with a very stable alignment stability, has been delivered by Boostec.

Engineering model of the EFI instrument with, on the top of the box in white, the two orthogonal sensor heads (COMDEV)

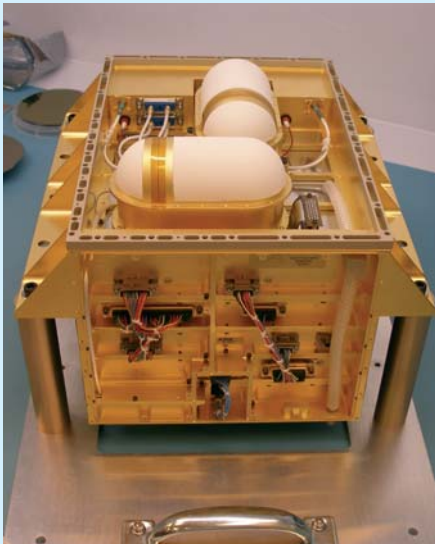

The contracts for the structural elements of the satellite, solar cells, and cold gas propulsion system have been initiated. The other major subsystems of the satellite like the On-Board Computer, GPS, the power conditioners and the S-band transponder are well advanced in design and engineering development. A preliminary coupled load analysis has been conducted with two back-up launchers. Results are still under evaluation by ESTEC and the satellite prime contractor. The qualification of the laser fibre assembly, laser diode and piezo-electric motor for the scalar magnetometer remains critical.

The Level 2 processor architecture, ionospheric current, mantle conductivity and air density algorithm studies are ongoing, paving the way for definition of the Level 2 processing.

MetOp

MetOp-A

The HRPT anomaly experienced by the MetOp-A spacecraft is still under investigation. The redundant HRPT-B on-board MetOp will not be switched on until the root cause of the anomaly is found, so

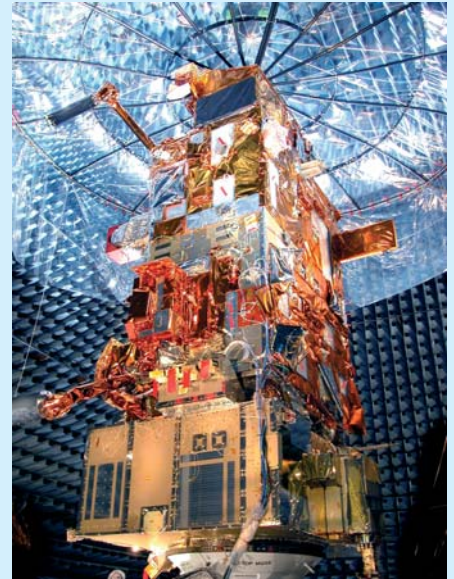

MetOp-A satellite at EADS Astrium's facilities in Toulouse (EADS Astrium)

the HRPT service to users continues to be provided by NOAA-17. The MetOp-A instrument performance is excellent.

MetOp-B and MetOp-C

The MetOp-B and MetOp-C Service and Payload Modules are still in long-term storage, until 2009 and 2010, respectively.

As fire fighters struggled to contain the blazes on the ground in Southern California, Eumetsat's MetOp-A polar-orbiting satellite was taking images from above with its Advanced Very High Resolution Radiometer. The infrared image clearly shows the hotspots of the fires, the smoke from which can be seen blowing over the Pacific and Baja California in the visible image (Eumetsat)



MSG

Meteosat-8/MSG-1

It has been confirmed that the spacecraft performance did not suffer from the object impact in May. After going through a complete seasonal cycle, the thermal situation is non-critical. The main effect now is a regular jump/slow recovery in spin axis tilt. The suspected cause is fluid migration triggered by the thermal event, and analysis is ongoing. Meteosat-8 is operating a 'rapid scan service' with the redundant thruster branch.

What this means: The MSG satellites normally scan the full Earth disc every 15 minutes. By scanning a smaller area, it is possible to scan more frequently. The rapid scan service covers approximately one-third of Earth's disc, covering from 15°– 70° N (including Europe), so the area is scanned every five minutes instead of every 15 minutes (see figure below).

Satellite and instrument performance remain of excellent quality.

Meteosat-9/MSG-2

Meteosat-9 has just completed its second year in orbit. Meteosat-9 is now Eumetsat's nominal operational satellite at 0° longitude, with Meteosat-8 as its back-up. Satellite and instrument performance are excellent.

Meteosat-8 rapid scan area (Eumetsat)

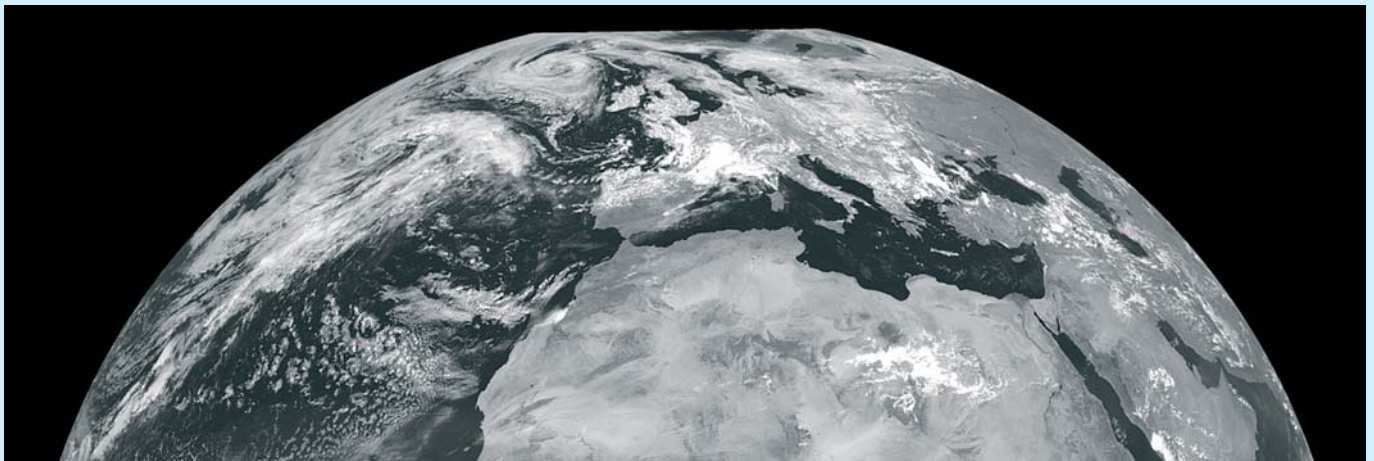

MSG-3

MSG-3 is still in intermediate storage in the Thales Alenia Space cleanroom, awaiting the restart of the AIT campaign in spring 2010, to prepare MSG-3 for its launch in early 2011.

MSG-4

MSG-4 has been moved to another building at Thales Alenia Space Cannes (V01), also in intermediate storage, awaiting completion of the MSG-4 Pre-Storage Review. The MSG-4 launch is planned for no earlier than 2013.

Vega

On 3 October, the Launch Vehicle System CDR was formally closed; four major actions are to be completed before the start of the qualification loop and are currently under way.

On 4 December, the P80 Demonstration Model firing test was successfully performed on the BEAP test bench, in Kourou; initial analysis confirms that the measurements are fully in line with predictions. On 20 December, the Modal Characterisation Test (MOCO) for Vega, to obtain the launch vehicle's modal parameters, was successfully completed.

On the Ground Segment, assembly of the Mobile Gantry main structure in Kourou was completed.



Successful P80 demonstration model firing test at Kourou

From the programmatic point of view, an additional slice of the Vega Development declaration has been subscribed by Italy and industrial activities have already been kicked off, dealing with the new Zefiro motor nozzle definition and implementation of the recommendations from the System CDR.

A Vega qualification flight mission carrying the Lares payload has been defined, and relevant discussions with ASI started.

In the next months, the Z23 Qualification Model firing test will take place.

Soyuz at CSG

Infrastructure activities (covering the Launch Control Centre, Launch Pad and buildings) are very close to completion, ready to receive Russian equipment by the end of spring 2008.

A meeting of all industries that will work on-site at Sinnamary has been organised, so that all parties are well informed of what is expected and can begin their own planning and responsibilities.

The Mobile Gantry working group has finalised the baseline configuration. Its CDR took place in December 2007 and has become an element of the programme critical path as the delivery is postponed to mid-2008.

The Safeguard Europe kit has been delivered to Russia in December. Russian qualification tests on the launcher will take place at the end of February.



The Expander Demonstrator rocket engine on its test stand at DLR's test facilities in Lampholdshausen, Germany

forum for Industry and Delegations from the FLPP Participating States to share technical and programmatic achievements and future perspectives of the programme.



Advancement of International Cooperation Award from the American Astronautical Society

international cooperation. The award was given at the 2007 National Conference of the American Astronautical Society (AAS), held 13/14 November in Houston, Texas.

International Space Station

As reported in last quarters' *Bulletin*, after a successful launch from the Kennedy Space Center (KSC) on 23 October 2007, Space Shuttle Discovery (flight STS-120/10A) transported the Italian-built Node-2 along with ESA Astronaut P. Nespoli (I) to the ISS on an ASI flight opportunity mission 'Esperia'. Harmony represented the first expansion of the living and working space on the station since 2001.

This image shows the tear in the jammed solar array on P6 (NASA)

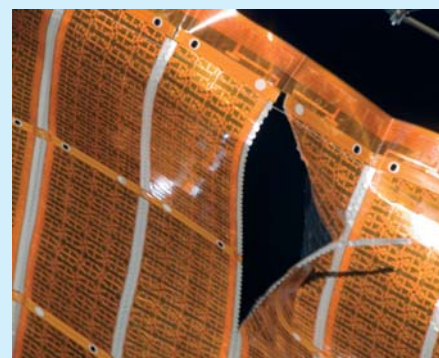

FLPP

The Concept Selection Meeting of the Building Blocks concept and NGL was held in mid-November.

The Expander Demonstrator test campaign is on-going. Engineering activities and component testing are going on in parallel; the status of technical activities will be assessed by a group of experts appointed and managed by ESA.

The IXV System Requirement Review was delivered in December. FLPP-1 Thrust frame activities are completed. The second set of Expander Demonstrator activities have started after signature of the corresponding rider in December.

A workshop for industry (the FLPP Industrial Workshop) was held at the beginning of February, with the objective of providing a

Human Spaceflight, Microgravity and Exploration

Highlights

The last few months of 2007 witnessed the beginning of the culmination of many years work for ESA and its industrial partners as 'Harmony' (Node 2) took its place on orbit with the International Space Station in preparation for the Columbus laboratory. Node-2 is the first of three major European elements going to the ISS, Columbus and ATV-1 (*Jules Verne*) being the other two, both planned for launch in early 2008.

ESA and its ISS partners were presented with the Advancement of International Cooperation Award in recognition of the significant contribution made by the ISS partnership in the advancement of

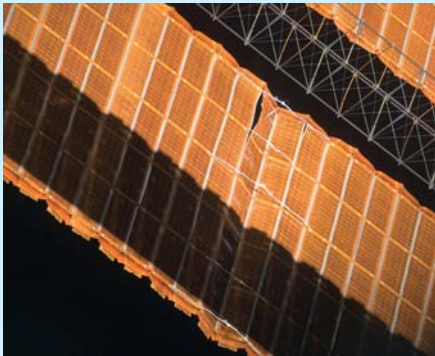

This image shows the tear in the jammed solar array on P6 (NASA)

There were, eventually, four EVAs executed during the mission: to install Harmony in a temporary position connected to Node-1; to detach the solar array set known as P6 and attach it to the extreme port end of the truss structure; and finally an unplanned EVA to repair a jammed solar array wing of P6 by means of 'cufflinks' constructed by the crew. If the damage had not been repaired it could have meant serious delays in the launch of the Columbus laboratory. The ability to problem solve 'on the spot' highlighted the advantage of human spaceflight.

After departure of the Shuttle, the ISS Expedition 16 crewmembers, using Canadarm-2, moved the Pressurized Mating Adapter-2 (PMA-2) from the front of the US laboratory, Destiny, to the Harmony node. In a second operation, Harmony, with PMA-2 on its outboard end, was moved from its temporary position on the Unity node to the front of the Destiny module. Harmony was then in its rightful position enabling future Space Shuttles to dock with the ISS and offer docking ports for ESA's Columbus laboratory and later for Japan's Kibo experiment module. The Increment 16 crew were congratulated on their hard work which allowed the schedule to stay unchanged.

Shuttle managers postponed planned launches of Shuttle *Atlantis* on 6 and 9 December because of false readings from the sensor system that monitors the liquid hydrogen section of the external tank. Two of four LH2 Engine Cut-off (ECO) sensors failed to respond appropriately during tanking of the external fuel tank. The system is one of several that protect the Shuttle's main

engines from catastrophic failure by triggering their shut down if fuel runs unexpectedly low. NASA formed a troubleshooting team to develop a plan of action to address the problem. After a meeting on 11 December, NASA technicians and engineers went ahead on 18 December with a test of the engine cut-off sensor system by pumping super-cold liquid hydrogen into the external fuel tank. The test, conducted on launch pad 39A at KSC, used additional instruments to pinpoint the problem that led to false readings during the two previous countdown attempts for *Atlantis*. The test concluded that the sensors were not the problem but that the fault was

in an open circuit in the 'feed-through' connector of the harness at the external tank wall. NASA engineers worked tirelessly and precisely to solder pins, only fractions of inches apart, to the sockets of the connector assembly, to prevent the open circuit. (The work was completed on STS-122/1E *Atlantis* and ESA's Columbus laboratory was launched in February 2008.)

Flight STS-123/1J/A is set to deliver the Japanese Kibo Logistics Module and the Canadian Dextre (Special Purpose Dexterous manipulator) and is scheduled for launch aboard Shuttle *Endeavour* in March 2008.



With umbilical lines still attached, the payload canister containing the European Columbus laboratory and Integrated Cargo Carrier-Lite (ICC-Lite) carrying the EuTEF and SOLAR payload suites, are seen lifted up toward the payload changeout room on Launch Pad 39A in early January 2008 (NASA)

Space Infrastructure Development and Exploitation

Following its delivery to the launch site in Kourou ATV-1 *Jules Verne* has progressed steadily through the planned ground processing tasks. The Qualification Review Board #2 (QRB2) was successfully completed and preparation is underway for the Flight Acceptance Review (FAR), completion of which will signal the start of the filling and fuelling activities.

At the end of November, *Jules Verne* was given its wings when the integration of the Solar Generation System (SGS) was completed. ATV's tanks were filled with drinking water for the ISS astronauts. This is the municipal water of Turin (Italy) that has been treated according to Russian standards. Dry cargo was also installed in the pressurised compartment of *Jules Verne* and the compartment closed up ready for launch.

The pressurised payload unit and the avionics/propulsion unit, the two major pieces of the *Jules Verne*, were carefully 'mated' for the last time in the final launch configuration on 15 December in the Spaceport's giant integration hall. In January the assembly of Ariane-5 ES and ATV will begin in readiness for its early March launch date.

On 7 October 2007, a successful on-orbit re-ignition of the Ariane-5 upper stage engine was performed which has consolidated Ariane-5's readiness for the launch of *Jules Verne*.

Node 3 has been advanced in the Assembly Sequence and is currently scheduled to launch October 2009 (with the Cupola attached) following delivery of Node-3 to NASA in February 2009.

Columbus Control Centre, Oberpfaffenhofen, Germany



Ariane-5 V178 lifts off for the upper stage engine re-ignition experiment in preparation for the launch of ATV-1 Jules Verne

Inaugurated in 2004 and situated in the German Aerospace Center (DLR)'s Oberpfaffenhofen location, the Columbus Control Centre (Col-CC) will control and conduct the flight operations of Columbus once it is attached to the ISS. The centre will also house the first permanent European astronaut communicator, or 'EUROcom'. The centre is operated by DLR under contract from ESA and Astrium. Manning 24 hours per day, European controllers on the ground will be responsible for managing the crew-occupied Columbus Laboratory. Col-CC is also connected to ESA's Crew Medical Support Office (CMSO), a full-time medical operations centre staffed by doctors and medical specialists located at ESA's European Astronaut Centre in Cologne, Germany. The CMSO will provide European astronauts with medical advice and monitoring while on board the ISS. All communications go via leased fibre-optic lines; commands are transmitted to the ISS via mission control in Houston, then to the NASA ground station in New Mexico and up to the ISS. All communications are, of course, encrypted to ensure security.

All qualification and simulation testing has been completed, and Col-CC is ready for its role.

ATV-CC operations qualification has continued on track for a launch in early February. Two more Joint Integrated Simulations (JIS) were successfully carried out and a major simulation exercise was conducted throughout the week of 26 November. This exercise, called 'Rendezvous Week', was a full simulation at ATV-CC of the demonstration part of the mission. It also exercised the ISS Programme Mission Management Team in Houston and Moscow in making decisions on whether or not the demonstration objectives had been achieved and on that basis giving the go-ahead for the next mission phase. This was an extremely important exercise and its successful completion has significantly increased the confidence of the ATV-CC operations teams as well as the ISS Programme management.

Utilisation

The Foton-M3 post flight activities are continuing nominally with the completion of

the outstanding technical verifications and contractual actions. All remaining flight hardware has been de-integrated and returned to ESTEC and further dispatched to the industrial contractors and/or scientists. A full mission report was received from TSSKB-Progress. Preliminary technical and scientific results were presented to the 3rd International Symposium on Physical Sciences held in Nara, Japan, 22/26 October and to the HME-SBD and PB-HME meetings at ESTEC. The 4th POLIZON science meeting was held on 10 December and initial evaluation of flight samples gives positive indications. The final presentation will be performed with all mission participants at ESTEC in March.

ESA's A300 Parabolic Flight programme was resumed with the 46th campaign after implementation of a safety process consolidation during 13/15 November with 11 technology development experiments and investigations in the fields of physical and life sciences. The 47th campaign was held just one month later 18/20 December in which 13 experiments were executed in micro-gravity conditions. The next ESA Parabolic Flight Campaign is scheduled to take place in March 2008.

Three drop tower campaigns were performed in the October time frame at ZARM/Bremen/D. In November a drop campaign on 'Interactions in Cosmic and Atmospheric Particle Systems (ICAPS)' took place but due to technical problems only six drops were executed; the remainder will be concluded in January 2008. Also in November the contract was submitted to ZARM for the 2008 and 2009 campaigns.

Soyuz 15S: The Malaysian spaceflight participant, M. Shukor (MY), and the Russian Increment 16 cosmonaut, Y. Malenchenko (RU) successfully performed a programme of two medical experiments and three biological experiments in a joint Malaysian National Space Agency/ESA experimental programme. During the ISS Increment 15 the Russian crew successfully completed ESA's research package of four experiments. In addition, a set of new dosimeters was installed in the human radiation phantom Matroshka for long-term measurements.



Columbus with the integrated ICC-Lite carrying the SOLAR and EuTEF payloads inside the cargo bay of Shuttle Atlantis (ESA)

The MULTIGEN-1 – Batch 1-A (Multi-generation Plant Growth in Space) experiment was completed aboard ISS in the European Modular Cultivation System (EMCS) during week 46. The dried-out plants will be returned to ground with STS-122/1E mission in February 2008. ANITA continues to operate flawlessly in Destiny and provides invaluable ISS atmosphere composition data.

The ISS Increment 16 experimental programme is ongoing since October with four long-term experiments in human physiology (ETD and Immuno) and radiation research (Matroshka and Altcriss). The Russian Expedition 16 crew will also undergo four post-flight experiments at Star City upon their return to Earth with Soyuz in April.

The Columbus payload hardware: the multi-user payload racks Fluid Science Lab (FSL), Biolab, European Physiology Modules (EPM) and the European Drawer Rack (EDR) as well as the passive European Transport Carrier (ETC) were integrated in their launch positions inside Columbus. Also the flight experiment for WAICO, GeoFlow and

FlyWheel has been stowed in Columbus. The external payload carrier (the so-called ICC-Lite) with EuTEF and SOLAR were also installed in the canister. Ground preparations are being prepared for the first Columbus related experiments. The impact of the STS-122/1E delay was coordinated with ESA Payload Ops, Mission Science Office (OPS-H and COL-CC teams). The 1E launch delay will imply a shorter 1E stage with some impacts on the on-orbit sequence of the WAICO and GEOFLOW experiments.

The peer reviews were completed with 15 proposals accepted for Mars-500 and eight for Concordia. The first analysis of 5610 candidates for Mars-500 has reduced the number to 216 who will now undergo further written medical examinations as the next stage in the filter process.

Astronauts

Following the approval by the September HME Programme Board, the extension of the arrangements between ESA, DLR and CNES until end 2010 concerning cooperation in the framework of the European Astronaut Centre Team were finalised. This permits the use of the expertise of DLR and CNES in the EAC Team, as well as the use of the DLR infrastructure at Cologne.

The next astronaut selection has been approved by the Programme Board in their November meeting and, since then, the preparation has been ongoing for a planned start in 2008.

After his return to Earth, P. Nespoli (I) enjoyed, along with the rest of the crew, the realisation of the extraordinary task they had performed and the immense interest and appreciation that their work had evoked. When he read the newspaper headline 'NASA at its best', Nespoli was proud and felt privileged to have been part of the mission that had carried such an essential component to the ISS making 'Esperia' an important milestone for Europe in space.

H. Schlegel (D) and L. Eyharts (F) continued training with the rest of the crew at KSC and awaited launch of STS-122/1E in early February 2008. For parts of the training

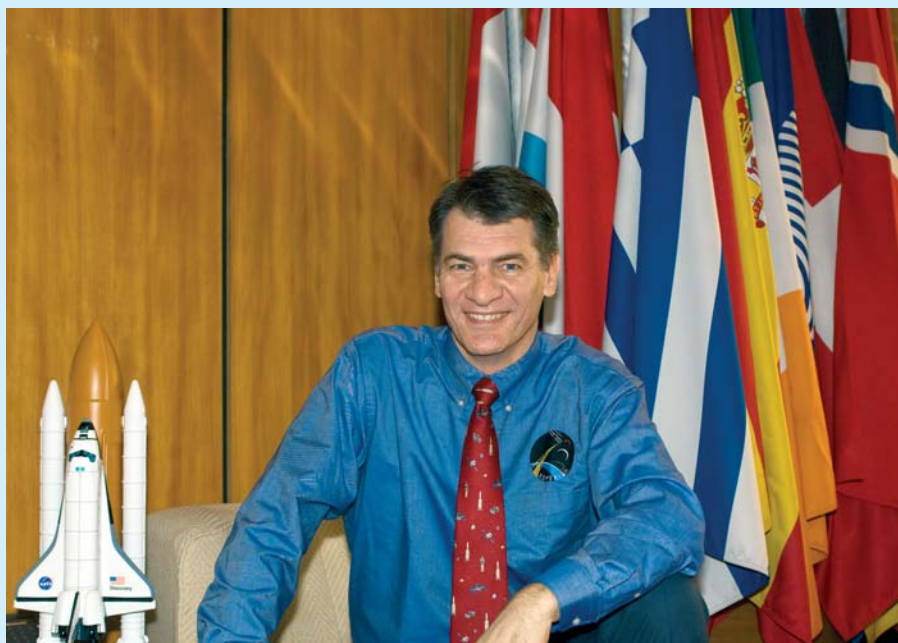

Nespoli back on terra firma

performed at JSC, ESA instructors were also involved as they were for the training of US astronauts G. Reisman and T. Kopra, as implemented by ESA instructors at JSC in November 2007.

At the EAC, training for ISS crew members was running full speed with ATV Part 1

Hans Schlegel and Léopold Eyharts during emergency evacuation training at Kennedy Space Center, Florida (ESA/S. Corvaja)



Exploration

ExoMars – The Enhanced Mission

The Enhanced ExoMars Mission will accommodate a much larger scientific payload than originally foreseen in 2005 and as a consequence requires a larger Descent Module to accommodate the Humboldt instruments in the Lander and the Pasteur instruments in the Rover. The Enhanced ExoMars Mission was endorsed by the PB-HME in November with an agreement to proceed to Phase-B2 and Advanced C/D activities to secure the 2013 launch date.

On 31 October, a committing proposal was received in response to the Request for Quotation (RfQ) released to Thales Alenia Space, Italy, (TAS-I), on 17 July. The evaluation process was completed positively on 20 December and a recommendation to proceed to the Phase-B2 and Advanced C/D activities as endorsed by the Programme Board allows the project to proceed.

Significant progress has been made in the detailed design of the mission and the Phase- B2 will start early in 2008 with the Prime and its industrial team. Technology developments, crucial to the Enhanced ExoMars mission, have progressed well and breadboards of the critical items, such as Vented Airbags, the Drill and Sample Preparation and Distribution System have demonstrated the feasibility of the mission in these critical areas.

The Enhanced ExoMars mission will require significant international cooperation with NASA, Roscosmos and the Lead Funding Agencies of the payloads. All the agreements for the cooperation with these various entities are now nearing completion and progress on the approvals is good. The Instrument Multilateral Agreements for the payloads will be signed by the Lead Funding Agencies and ESA in early 2008.

Generally, the project is accelerating activities towards a system Preliminary Design Review (PDR) at the end of 2008. In parallel, preparations for the Council of Ministers 2008 will continue in order to achieve a full approval of the Enhanced ExoMars Mission.



Technology developments crucial to Enhanced ExoMars have been made, such as tests of Vented Airbags

Core Element

The Invitations to Tender for the Next Exploration, Science and Technology mission studies, funded by the General Studies Programme, were issued on 16 November.

Science Definition Teams have been nominated for both missions, with participation from the scientists who submitted proposals in response to the 'Call for Ideas', and work was kicked-off at the

Drill breadboard for Enhanced ExoMars

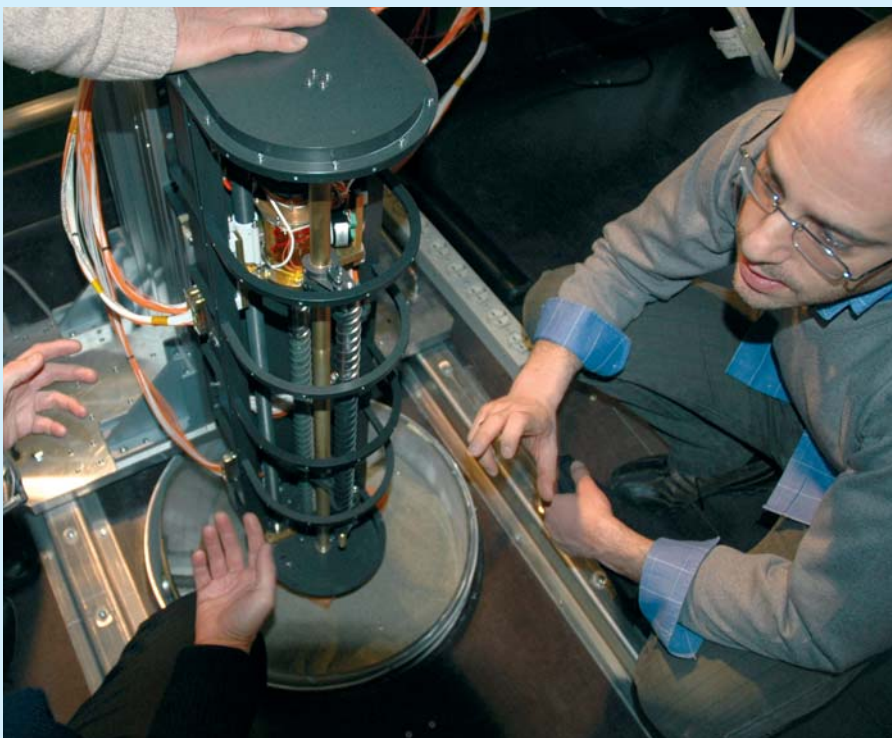

joint Mars Express and ExoMars conference in ESTEC in the week of 12 November. A final version of the Core Work Plan was approved by the HME Programme Board at their November meeting.

In the frame of the International Mars Exploration Working Group, a sub-group, IMARS, has been established dedicated to the definition and preliminary design of an International Mars Sample Return mission definition. A commonly agreed mission concept is expected by mid-2008.

CSTS

European and Russian industry started joint work, in early September, focused on the definition of the CSTS requirements for Low Lunar Orbit and Low Earth Orbit missions. Roscosmos and ESA have jointly selected for the purpose of further work the vehicle concept to be a modular vehicle consisting of a 'headlight' Soyuz-type capsule; a habitation module; and a service/propulsion module. RSC-Energia and European industry are now working on the preliminary design of the vehicle at system and subsystem level.

Strategy for Human Spaceflight, Microgravity and Exploration Programmes

The status of Lunar Exploration Architecture Development was presented at the International Conference for Exploration and Utilisation of the Moon, held in Sorrento 22-26 October.

The International Space Exploration Coordination Group had a successful meeting in Berlin on 6-7 November. Presentations were given covering the status of ESA space exploration plans and the concept of the International Space Exploration Coordination Tool.

The International Space Exploration Conference took place on 8/9 November in Berlin with 350 participants from industry, research organisations, academia, agencies, public organisations, political institutions and media. During the two days of the conference the outline of a European long-term strategy for space exploration was discussed. 

In Brief



Seen against the blackness of space, ESA's Columbus laboratory sits in the aft portion of Space Shuttle Atlantis' cargo bay just before the Shuttle's docking to the International Space Station. The addition of Columbus to the ISS signals the start of a new era in European space exploration and makes history as the first European laboratory dedicated to long-term research in space

Dawn of a New Era – Columbus in Pictures





Hans Schlegel, STS-122 mission specialist, dons his Shuttle launch and entry suit at the start of a training session



Léopold Eyharts, Expedition 16 flight engineer, adjusts his 'snoopy' communications headset during suiting up preparations (seen here during a training session)



After suiting up, the STS-122 crewmembers leave the Operations and Checkout Building at Kennedy Space Center on their way to Launch Pad 39A for the launch of the STS-122 mission. On the right (front to back) are astronauts Steve Frick, Rex Walheim and ESA's Hans Schlegel. On the left (front to back) are astronauts Alan Poindexter, Leland Melvin, Stanley Love and ESA's Léopold Eyharts



Léopold Eyharts, NASA astronaut Stanley Love and Hans Schlegel seated on the mid-deck of the Shuttle as they would be for launch, seen here during a training session in the Space Vehicle Mockup Facility



The setting Sun behind Space Shuttle Atlantis carrying Columbus on the eve of launch at NASA's Kennedy Space Center, Cape Canaveral, Florida (NASA/Bill Ingalls)



Columbus, the Space Shuttle Atlantis and its seven-member crew head into space. Lift-off from Kennedy Space Center was at 20:45 (CET) on 7 February 2008



A few minutes after launch, the exhaust trail of Space Shuttle Atlantis (STS-122) is seen through the windows of the Launch Control Center at the Kennedy Space Center



A smiling Léopold Eyharts enjoys lunch in the Shuttle's cockpit



Hans Schlegel pauses for a photo while working on the mid-deck of Space Shuttle Atlantis during the second day's flight activities



Columbus is moved slowly towards the starboard side of the Harmony module on 11 February 2008. Now that Columbus is attached to the ISS, ESA becomes responsible for the operations and utilisation of the ISS and will thus be entitled to fly its own astronauts for long-duration missions as members of resident ISS crews



Floating near Columbus, Hans Schlegel makes his first-ever spacewalk outside the ISS, the second spacewalk of the STS-122 mission, lasting six hours 45 minutes. Schlegel and NASA astronaut Rex Walheim made the spacewalk to replace a nitrogen tank used to pressurise the Station's ammonia cooling system



Schlegel is a very happy spacewalker!

ESTRACK Welcomes Santa Maria Station



The Portuguese Minister of Science, Technology and Higher Education, Prof. José Mariano Gago, shakes hands with Gaelle Winters, ESA's Director of Operations and Infrastructure, at the formal inauguration of Santa Maria station, 17 January 2008



The new 5.5 m tracking station on Santa Maria island has been formally inaugurated into ESTRACK, the ESA tracking station network. The Santa Maria S-band station, also known as 'Montes das Flores' (Hill of Flowers), is located 5 km from the town of Vila do Porto on the Portuguese island of Santa Maria,

in the Azores, some 1500 km from Lisbon.

Santa Maria is one of the first ESTRACK stations with launcher tracking capability and is used to receive real-time telemetry from launches originating from ESA's spaceport in Kourou, French Guiana. The station will be used

to track Ariane launch trajectories and will also be capable of tracking Vega and Soyuz, as well as ongoing Earth observation missions, including ESA's ERS-2 and Envisat.

The Santa Maria station tracking footprint covers a large portion of the Atlantic ocean. The first

launch to be tracked from Santa Maria will take place in early 2008, when *Jules Verne*, the first Automated Transfer Vehicle to be sent to the International Space Station, lifts off from Europe's Spaceport in French Guiana on board an Ariane-5 launcher.



Earth Observation Training for African Water Authorities

Some 30 water authorities from more than 15 African countries gathered in Nairobi, Kenya, in November to attend an advanced ESA TIGER training course on using Earth Observation technology to overcome water-related problems.

"The course was very useful, especially for those in the field, as tools are very limited in Africa," said Patrick Khisa of Kenya.

Khisa said the course, hosted by the Regional Centre for Mapping of Resources for Development, helped him to identify how and



where to get data for wide-scale applications. For instance, until recently he has been monitoring the water levels of Lake Victoria using ground data. During the course, he learned that he could monitor lake levels using data

from the space-based instrument radar altimeter.

The course provided an overview of the different applications of Earth Observation (EO) technology for water resource management,

with special attention placed on the needs of Africa. European and African experts discussed various topics, such as catchment characterisation, hydrological modelling, water quality and drought forecasting.



Ice Clouds put Mars in the Shade

Until now, the fourth planet from the Sun has generally been regarded as a desert world, where a visiting astronaut would be surprised to see clouds scudding across the orange sky. However, new results show that the arid planet possesses high-level clouds that are sufficiently dense to cast a shadow on the surface.

Mars is not entirely a haven for Sun worshippers. Clouds of water ice particles do occur, for example on the flanks of the giant Martian volcanoes. There have also been hints of much higher, wispy clouds made up of carbon dioxide (CO₂) ice crystals. This is not too

surprising, since the thin Martian atmosphere is mostly made of CO₂, and temperatures often plunge well below the freezing point of CO₂.

Now a team of French scientists has shown that such clouds of dry ice do, indeed, exist. Furthermore, they are sometimes so large and dense that they throw quite dark shadows on the dusty surface.

The results were obtained by the OMEGA Visible and Infrared Mineralogical Mapping Spectrometer instrument on board ESA's Mars Express.

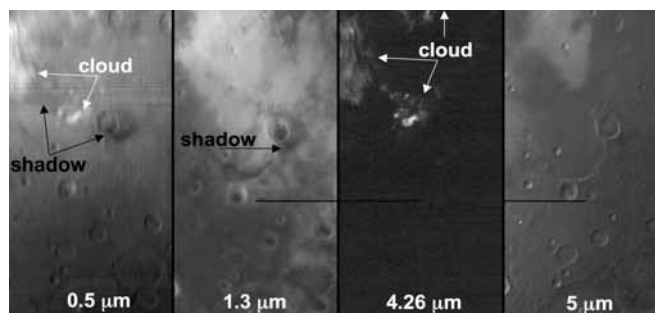

"This is the first time that carbon dioxide ice clouds on Mars have been imaged and identified from above," said Franck Montmessin of the Service d'Aéronomie, University of Versailles (UVSQ).

"The clouds imaged by OMEGA can reduce the Sun's apparent

brightness by up to 40%. This means that they cast quite a dense shadow and this has a noticeable effect on the local ground temperature. Temperatures in the shadow can be up to 10°C cooler than their surroundings, and this in turn modifies the local weather, particularly the winds." 

Mars now Seen in 3D

Mars is about to come into 3D focus as never before, thanks to data from the High Resolution Stereo Camera (HRSC) on ESA's Mars Express. A new high-resolution Digital Terrain Model data set that has just been released on the Internet will allow researchers to obtain new information about the 'Red Planet' in 3D.

Digital Terrain Models (DTMs) allow scientists to 'stand' on planetary surfaces. Although ordinary images can give spectacular bird's-eye views, they can only convey part of the picture. They miss out on the topography, or the vertical elevation of the surroundings.

The HRSC was especially designed to provide this information and, after years of specialised data processing, the first comprehensive release of 3D data of a large part of the martian

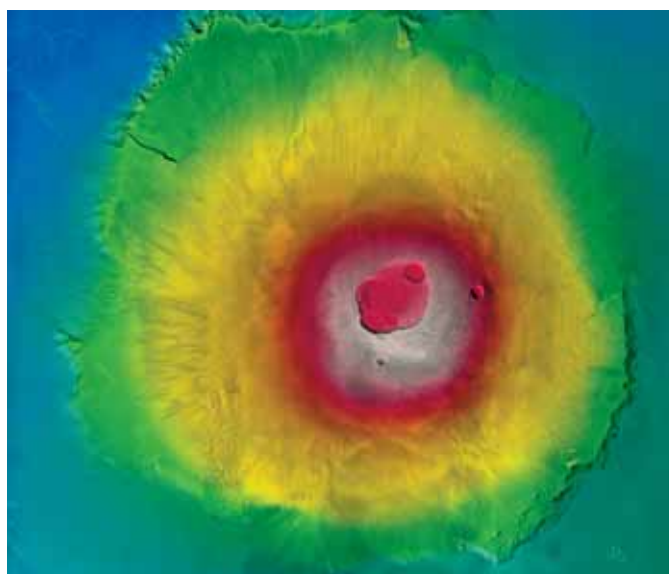

Olympus Mons, the highest volcano on Mars, towering 26 km above the surrounding plains. The image covers an area of approximately 600 000 sq km and is colour-coded according to height based on data from the Digital Terrain Model (ESA/DLR/FU Berlin G. Neukum)

surface is now ready. The Mars Express DTM is the most detailed topographic data set ever released for Mars. Its release has been made possible by processing individual image swaths taken by

the HRSC as Mars Express sweeps through its orbit. The individual swaths are then put together into mosaics that cover large regions. The high-resolution images used have a resolution of

10 m/pixel. The DTM elevation data derived from these images is provided in pixels of up to 50, with a height accuracy of 10 m.

More data will be added to the DTMs to extend the surface coverage as Mars Express continues its mission until at least 2009 and HRSC continues its unique scrutiny of the planet.

The Mars Express-HRSC DTMs are available to the science community at large through the archives at the Planetary Science Archive (<http://www.rssd.esa.int/PSA>) at ESA and the Planetary Data System (http://pds-geosciences.wustl.edu/missions/mars_express/hrsc.htm) at NASA. A joint website of Free University Berlin and DLR allows the general public to view the data on line at <http://hrscview.fu-berlin.de> 

ESAC Inauguration



Their Royal Highnesses are greeted here by ESA's Gaelle Winters, Fernando Doblas and Alvaro Jiménez



The Prince and Princess unveil the plaque at ESAC watched by Prof. David Southwood and Vicente Gomez

ESA's European Space Astronomy Centre (ESAC), located on the outskirts of Madrid, was inaugurated by Their Royal

Highnesses The Prince and Princess of Asturias on 7 February. ESAC is ESA's new base for astrophysics and Solar

System missions, and is a centre of excellence for space science.

The event was also attended by the Spanish Minister for Industry, Joan Clos; the Head of the Spanish Delegation to ESA, Maurici Lucena; and the Major of Villanueva de la Cañada, Luis Partida. On behalf of ESA, the

dignitaries were welcomed by ESA's Director of Science, David Southwood; ESA's Director of Operations, Gaelle Winters and the Head of ESAC, Vicente Gómez. In representation of the aerospace sector was the General Director of INTA, Fernando González.



ESA and EC Take a Major Step Forward in GMES

ESA and the European Commission have signed a €48 million data access grant, marking the first real cooperation between the two in the GMES framework.

The Global Monitoring for Environment and Security programme is led by the European Union in partnership with ESA. It will monitor the environment, combining observations both from the ground and from space.

The grant considers the Earth Observation data needs of GMES services and covers analysis of the service requirements and negotiation of data access agreements with other

contributing missions, mainly from ESA Member States. ESA's role is to coordinate and implement the dedicated GMES Space Component, which involves developing the five Sentinel satellites, plus the Ground Segment, and to coordinate data access.

The GMES services include three fast-track services focusing on land, marine and emergency, and two pilot service projects focusing on security and atmospheric composition.

"GMES is the European solution for the needs of citizens in Europe to access reliable information on the status of their environment," according to EC Vice-President Günter Verheugen. 

Take Your Classroom Into Space

With ESA's Columbus laboratory safely attached to the ISS, this is a good time to come up with new ideas for experiments that can be carried out on board the station. ESA has invited to European teachers and educators to come up with ideas that use the ISS to illustrate the effects of weightlessness to students.

There will be prizes for the 20 best proposals – those that can be performed in parallel on board the ISS and in the classroom, since this is a very effective way to illustrate the effects of weightlessness.

In July, work will start on preparing some of the very best experiments for flight to the ISS, where an ESA astronaut will carry out the experiments. Students across Europe will be given a unique opportunity to witness the 'classroom in space', and hopefully simultaneously to perform the experiment in their own classroom.

Proposals should be sent in by 30 May 2008. For more information please see www.esa.int/esaCP/SEMLGRUJJ_Cf_index_0.html or e-mail: isseducationteam@esa.int 

ESOC Hosts Visit From UK Science Minister

The UK Minister of State for Science and Innovation, Ian Pearson, visited ESA's European Space Operations Centre in January, the first-ever such visit from a British minister.

Mr Pearson held discussions with ESA Director General Jean-Jacques Dordain; he was also updated on current and future European space activities and on the strong participation of UK industry in ESA programmes. He was guided on a tour of ESOC's satellite control facilities and was briefed on ESOC's roles by Gaelle Winters, Director of Operations for ESA and ESOC Head of Establishment. He also met with UK national staff and industrial contractors working on site.

"UK science and industry have played a strong part in the success of ESA missions and constitute a solid and competitive basis for a stronger role in future ESA activities," said Jean-Jacques Dordain. 



Jean-Jacques Dordain with the UK's Ian Pearson

Contest Winner Visits Florida



Daniela Petrova at Kennedy Space Center

The ESA Columbus Essay Contest, a competition for European university students to write about 'The value of human spaceflight for European citizens', has been won by a British medical student from University College London.

Andreas Diekmann, Head of the Human Exploration Promotion Division, said, *"We hoped that such a topic would stimulate an interest in human spaceflight among a wider group of students, and not only those studying science and*

engineering. Indeed the result was a wide spectrum of replies, from across all Member States, and faculties ranging from medicine, design research, international business administration and economics, to engineering and technology."

"We achieved our aim to challenge students to think about human spaceflight, and in particular familiarise themselves with ESA and its research activities. We also gained deeper understanding of the interest of the younger generation in science and technology. This is of value for all ESA, not only for Human Spaceflight."

From the essays submitted, there was a clear winner: Daniela Petrova, a medical student from the UK, who chose to write her essay in rhyme. The second prize

went to Benjamin Lenoir, a French aerospace engineering student, and the third prize to Regina Peldszus, a British design student.

Daniela explained, *"I attempted to demonstrate the practical benefits of human spaceflight for Earth development and for a variety of societies, as well as the benefits of international cooperation, and the space missions for the exploration ideology itself."*

Daniela's prize was a trip to the Kennedy Space Center in Florida during the first launch window for the Space Shuttle *Atlantis* with Columbus on board. During this visit Daniela saw some of the training facilities and met some of the astronauts, designers and programmers who support the Shuttle missions. Daniela's poem is reproduced overleaf. 

The Value of Human Spaceflight for European Citizens

By Daniela Petrova

What is the value of human
Spaceflight for the European?
Some people perhaps feel detached
From the human spaceflight touch,
Perhaps because they have not been
To the heights beyond our atmospheric screen,
Perhaps because they have not touched
A rocket or its launching pad,
Perhaps because they have never thought
How much we owe to this field wrought.
Yet despite it all, each and every one of us,
Has benefited from this research thus,
Let's remind ourselves in brief
Why we value the human spaceflight leitmotif.

There are benefits innumerable: the societal,
Multi-national, cultural, environmental.
Research, health and education,
Technology, business and innovation.
We value all the things
That would eliminate poverty, disease
And lead to world peace.
So when we look so closely,
At the common values we hold mostly,
It is possible to see revealed
That all our actions in this field
Have led to the improvement rife
For better living standards and quality of life.

Before recounting in more detail
There is a drop of history to feel.
Without the numerous inventors
That have given us the transportation by land, sea and air favours,
The engines and mechanics
On which such as Karl Benz and Felix du Temple
worked despite the sceptics;
If it was not for the aspiration to the Moon
In Jules Verne's De la Terre à la Lune
or Beethoven's Moonlight Sonata's passion,
Then where would be our inspiration?!
Following our lengthy history
Of exploration and glory
In the post-Apollo mission,
Which made reality out of fiction,

ESA significantly contributed
In Spacelab and subsequently distributed
Work to many a European astronaut
From Thomas Reiter to Ulf Merbold
Moulding the European future
As a leading human spaceflight figure.
Today, with permanent human occupation
Aboard the International Space Station
We have had, still do and will, the opportunity
To utilise the unique conditions of microgravity.

Now to mention more specifically,
The value for our society and industry.
The European Commission rightfully recognised the potential
For economic growth, jobs and industry as essential
In the contribution to international cooperation,
Political and industrial cohesion, and multicultural integration.
With increasing international coordinations
And growing peace between nations
There will be military resource translocation
From the army towards peaceful space exploration.

Human spaceflight has an important action
In all of the above and education.
Not only in scientific principle demonstration
But also in fundamental inspiration,
Offering the future generation
A role-model for aspiration.
Consequently, there have been developed
Education projects that have enveloped
European students in science,
Mathematics, languages and art brilliance
As well as parabolic flights
That will lift them to new heights.
After many decades of human spaceflight experience
We have moved beyond adventure
To acting as a technological aider.

Extraterrestrial research has allowed us to explore
Theories of relativity and origins of life closer
Thanks to Earth observation and successful navigation
Disasters are averted between planes, ships and transportation
Weather prediction and communication
Have allowed emergency evacuation

Avoiding the consequences of natural disasters and losses.
 Laser-cooled atomic clock developments
 Allow for new, ultra precise measurements
 While studies in Interactions
 Between Cosmic and Atmospheric Particle Systems
 Allow better understanding of pollutants and cloud formation
 For future successful manipulation.
 Astronauts have played a crucial part to date
 To observe, interpret, adjust and update
 Experiments for a successful mission,
 Which with only robots would go without completion.

Human space exploration
 Also provides a unique occasion
 For testing interactions
 between robotics and humans.
 The European Robotic Arm marks a new ERA
 Of amplified human strength of a new gear.
 The extreme space environment
 Has led to the development
 Of many high performance materials
 For golf clubs, artificial hips and Shuttles
 High in insulation, durability
 Corrosion and weight stability.
 Further valuable spin-offs being
 In construction and engineering
 Providing better insulation
 Air conditioning and water purification
 Which is as readily applicable to business centres
 As to Third World countries and remote sectors.

Increasing environmental awareness
 Has led to questioning of process and resource
 Utilisation, so that the closed loop system
 Has become a primary concern.
 Human spaceflight research
 Has led to as much
 As seventy percent success
 In recycling excess.
 Regeneration of air and clean water
 With some food production (even better)
 Will be applicable in any extreme
 Or closed environment for many
 Whether in remote Antarctica, Africa, Sahara
 Further than Mars, in a submarine, plane or tundra.

In addition, human spaceflight
 Has helped develop new medicines to fight
 Negative physiologic adaptations
 Both in space and for Earth's millions.
 Portable and automated devices

Lead to new diagnostic choices
 For cardiovascular disease
 To prevent its incipient malice;
 The ESA Flywheel Exercise Device
 Offers new rehabilitation and athletics exercise
 While Euromir-95 mission's 'Osteospace'
 Offers a safe ultrasound alternative to X-rays;
 Ophthalmological and neurological examination
 Has benefited from the VOG and 3D-eye tracker detection;
 Respiratory Gas Analysers
 Efficiently predict disfunctions,
 And ultraviolet protection is now available
 For children with Xeroderma Pigmentosum,
 While the Mamagoose suite preserves the breath
 Of babies from cot death.
 Such remarkable scientific advances,
 Due to human spaceflight rises,
 Have led to increasing numbers
 Of European centenarians.
 Like a feedforward reaction
 Human spaceflight attraction
 Returns its investment many times over
 By preventing disease or early death after.
 The saved money in return
 Can be used for a further space concern
 So it becomes cheaper and cheaper
 To carry out missions in our favour.

The value of human spaceflight until now is unquestionable
 And with Columbus' laboratory it will grow increasingly valuable.
 Beyond the low Earth orbit
 The future holds a further field,
 That of explorations,
 Of new worlds and destinations:
 Initially to the Moon, Mars and Europa
 Then to satellites and planets much further.
 For there are many promises in the lands around us
 Ice and water, stones and precious dust,
 Like Helium-3, which will likely provide,
 In future, clean and efficient energy might.

Our planet is like a rocky island
 Suspended by an invisible hand
 Into an ocean of space
 Within which there are paths to trace.
 Like Columbus and many others,
 Who ventured across unprecedented expanses
 And braved unknown perils
 So that we may conquer the riddles,
 Like the tamers of the land and sea
 We tame the values in air and space we see!

Publications

The documents listed here have been issued since the last publications announcement in the ESA Bulletin. Requests for copies should be made in accordance with the Table and Order Form inside the back cover

Newsletter

Connect No. 01/08 February 2008
Newsletter of ESA's Directorate of Applications
 Fletcher K. & Peeren K. (Eds.)
 No charge



18th ESA Symposium on European Rocket and Balloon Programmes and Related Research, 3-7 June 2007, Visby, Sweden (November 2007)
 L. Conroy (Ed.)
 ESA SP-647 // 628 pp
 Price: 50 Euro



ESA Special Publications

Proceedings of the 6th Integral Workshop – The Obscure Universe, 2-8 July 2006, Moscow, Russian Federation (September 2007)
 S. Grebenev, R. Sunyaev & C. Winkler (Eds.)
 ESA SP-622 // 682 pp
 Price: 60 Euro



Report on the Activities of the Research and Scientific Support Department 2005–2006 (October 2007)
 M. Kessler & K. Fletcher (Eds.)
 ESA SP-1307 // 176 pp
 Price: 30 Euro



ESA Scientific & Technical Memoranda

Calibration of Particle Instruments in Space Physics (December 2007)
 M. Wüest, D.S. Evans & R. von Steiger (Eds.)
 ESA SR-007 // 588 pp
 Price: 60 Euro

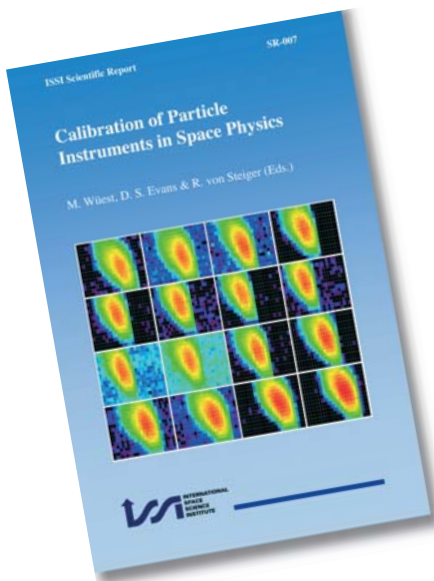

Mutual Influence between Flow Compressibility and Chemical-Reaction Rates in Gas Mixtures
 K. Fletcher (Ed.)
 ESA STR-255 // 48 pp
 Price: 10 Euro

ESA History Books

A Short History of Swedish Space Activities (December 2007)
 K. Fletcher (ed.)
 ESA HSR-39 // 64 pp
 Price: 20 Euro

ESA Contractor Reports

Space Palmtop Applications (October 2005)
 Therma, The Netherlands
 ESA CR(P)-4602 // CD-Rom
 Price: 25 Euro

MEMS Technology for Terminals and Satellite Antennas – Final Report (2005)
 Alcatel Alenia Space
 ESA CR(P)-4603 // CD-Rom
 Price: 25 Euro



A full listing of ESA publications is available at www.esa.int/publications

Publications Available from the European Space Agency

| Publication | Number of issues per year | Scope/Contents | Price € | Source |
|--|---------------------------|--|----------------|---|
| ESA Bulletin | 4 | ESA's house magazine | Free of charge | ESA Communications |
| Connect | 2 | Telecommunications newsletter | " | " |
| ECSL News | 4 | News from the European Centre for Space Law (under ESA auspices) | " | " |
| Eurocomp | 2 | Newsletter of the Space Components Steering Board | " | " |
| Monographs | | | | |
| | Code | | | |
| Conference Proceedings | (SP-xxx) | Collections of papers presented at ESA conferences/symposia | Prices vary | ESA Communications |
| Special Publications | (SP-xxxx) | Detailed monographs on ESA programmes/projects | " | " |
| Brochures | (BR-xxx) | Concise summaries on ESA programmes/projects | " | " |
| History Study Reports | (HSR-xxx) | Detailed monographs on ESA-related space history | " | " |
| Scientific & Technical Reports | (STR-xxx) | Reflecting ESA's position on a given subject | " | " |
| Scientific & Technical Memoranda | (STM-xxx) | Latest but not finalised thinking on a given subject | " | " |
| European Cooperation for Space Standardization | (ECSS-xxx) | Definitive requirements in support of ESA contacts | " | " |
| Training Manuals | (TM-xxx) | Series for education of users or potential users of ESA programmes, services or facilities | " | " |
| Public relations material | | General ESA literature, posters, photographs, films, etc. | | ESA Communication Dept. 8-10 rue Mario-Nikis 75738 Paris 15, France Tel: +33 1 5369 7155 Fax: +33 1 5369 7690 |

Periodicals and selected monographs are also available at:

<http://www.esa.int/publications>

Order Form for ESA Publications

No publications sent before receipt of payment in Euros (€)

| No. of copies | ESA reference no. | Title | Price per copy/€ | Total € |
|---------------|-------------------|-------|------------------|---------|
| | | | | |
| | | | | |
| | | | | |
| | | | | |
| | | | | |
| | | | | |
| | | | | |
| Total amount | | | | |

Mailing address *(please print carefully)*

Name

Function

Organisation

Address

Post Code

Country

Date

Signature

Cheque enclosed (made payable to ESA Publications)

Return Order Form with cheque to:

ESA Communications – ESTEC – PO Box 299 – 2200 AG Noordwijk – The Netherlands

Items ordered are free of charge

Charge to:

Eurocard/Mastercard*

Visa

AmEx

Card No.

Expiry date

*Mastercard: include Security Code located on back of card above signature – 3 digits

Card Holder's Name

Return Order Form to:

Publications Bookshop – ESA Communications – ESTEC

PO Box 299 – 2200 AG Noordwijk – The Netherlands; Fax: +31 (0)71 565 5433

Telephone orders (and further information): +31 (0)71 565 3405

Information via e-mail: esapub@esa.int

Internet – List of past publications: <http://www.esa.int/publications>

Member States

Austria
Belgium
Denmark
Finland
France
Germany
Greece
Ireland
Italy
Luxembourg
Netherlands
Norway
Portugal
Spain
Sweden
Switzerland
United Kingdom

Etats membres

Allemagne
Autriche
Belgique
Danemark
Espagne
Finlande
France
Grèce
Irlande
Italie
Luxembourg
Norvège
Pays-Bas
Portugal
Royaumi-Uni
Suède
Suisse

European Space Agency
Agence spatiale européenne

ESA Communications
ESTEC, PO Box 299, 2200 AG Noordwijk, The Netherlands
Tel: +31 71 565-3400 Fax: +31 71 565-5433
Visit Publications at <http://www.esa.int>

